

DENON

DVD HOME ENTERTAINMENT SYSTEM

S-302

Owner's Manual

Manuel de l'Utilisateur

Manual del usuario

GUI *Graphical User Interface*

English

Use this manual in combination with the operating guide displayed on the GUI screen.

GUI Menu Operations (☞ page 16)

GUI Menu Map (☞ page 17)

Language (☞ page 18)

Remote Control Unit Operations (☞ page 40)

Français

Utilisez ce manuel en même temps que le guide d'utilisation affiché sur l'écran GUI (Interface graphique).

Utilisation du menu de l'interface graphique (☞ page 16)

Carte du menu (☞ page 17)

Langue (☞ page 18)

Fonctionnement de la télécommande (☞ page 40)

Español

Utilice este manual conjuntamente con la guía de uso que aparece en la pantalla GUI.

Operaciones del menú GUI (☞ página 16)

Mapa del menú de la GUI (☞ página 17)

Idioma (☞ página 18)

Operaciones con el mando a distancia (☞ página 40)

SAFETY PRECAUTIONS



CAUTION
RISK OF ELECTRIC SHOCK
DO NOT OPEN



CAUTION:
TO REDUCE THE RISK OF ELECTRIC SHOCK, DO NOT REMOVE COVER (OR BACK). NO USER-SERVICEABLE PARTS INSIDE. REFER SERVICING TO QUALIFIED SERVICE PERSONNEL.

The lightning flash with arrowhead symbol, within an equilateral triangle, is intended to alert the user to the presence of uninsulated "dangerous voltage" within the product's enclosure that may be of sufficient magnitude to constitute a risk of electric shock to persons.

The exclamation point within an equilateral triangle is intended to alert the user to the presence of important operating and maintenance (servicing) instructions in the literature accompanying the appliance.

WARNING:
TO REDUCE THE RISK OF FIRE OR ELECTRIC SHOCK, DO NOT EXPOSE THIS APPLIANCE TO RAIN OR MOISTURE.

LASER SAFETY
 CLASS II LASER PRODUCT

CAUTION:
VISIBLE AND INVISIBLE LASER RADIATION WHEN OPEN.
DO NOT STARE INTO BEAM.
LOCATION: INSIDE, NEAR THE DVD DRIVE MECHANISM.

CAUTION:
USE OF CONTROLS OR ADJUSTMENTS OR PERFORMANCE OF PROCEDURES OTHER THAN THOSE SPECIFIED HEREIN MAY RESULT IN HAZARDOUS RADIATION EXPOSURE.
THIS PRODUCT SHOULD NOT BE ADJUSTED OR REPAIRED BY ANYONE EXCEPT PROPERLY QUALIFIED SERVICE PERSONNEL.

Copyrights / Droits d'auteur / Derechos de Autor

- It is prohibited by law to reproduce, broadcast, rent or play discs in public without the consent of the copyright holder.
- La reproduction, la diffusion, la location, le prêt ou la lecture publique de ces disques sont interdits sans le consentement du détenteur des droits d'auteur.
- De acuerdo con las leyes está prohibido reproducir, emitir, alquilar o interpretar discos en público sin la autorización del propietario de los derechos de autor.

SAFETY INSTRUCTIONS

- Read Instructions – All the safety and operating instructions should be read before the product is operated.
- Retain Instructions – The safety and operating instructions should be retained for future reference.
- Heed Warnings – All warnings on the product and in the operating instructions should be adhered to.
- Follow Instructions – All operating and use instructions should be followed.
- Cleaning – Unplug this product from the wall outlet before cleaning. Do not use liquid cleaners or aerosol cleaners.
- Attachments – Do not use attachments not recommended by the product manufacturer as they may cause hazards.
- Water and Moisture – Do not use this product near water – for example, near a bath tub, wash bowl, kitchen sink, or laundry tub; in a wet basement; or near a swimming pool; and the like.
- Accessories – Do not place this product on an unstable cart, stand, tripod, bracket, or table. The product may fall, causing serious injury to a child or adult, and serious damage to the product. Use only with a cart, stand, tripod, bracket, or table recommended by the manufacturer, or sold with the product. Any mounting of the product should follow the manufacturer's instructions, and should use a mounting accessory recommended by the manufacturer.
- A product and cart combination should be moved with care. Quick stops, excessive force, and uneven surfaces may cause the product and cart combination to overturn.
- Ventilation – Slots and openings in the cabinet are provided for ventilation and to ensure reliable operation of the product and to protect it from overheating, and these openings must not be blocked or covered. The openings should never be blocked by placing the product on a bed, sofa, rug, or other similar surface. This product should not be placed in a built-in installation such as a bookcase or rack unless proper ventilation is provided or the manufacturer's instructions have been adhered to.
- Power Sources – This product should be operated only from the type of power source indicated on the marking label. If you are not sure of the type of power supply to your home, consult your product dealer or local power company. For products intended to operate from battery power, or other sources, refer to the operating instructions.
- Grounding or Polarization – This product may be equipped with a polarized alternating-current line plug (a plug having one blade wider than the other). This plug will fit into the power outlet only one way. This is a safety feature. If you are unable to insert the plug fully into the outlet, try reversing the plug. If the plug should still fail to fit, contact your electrician to replace your obsolete outlet. Do not defeat the safety purpose of the polarized plug.
- Power-Cord Protection – Power-supply cords should be routed so that they are not likely to be walked on or pinched by items placed upon or against them, paying particular attention to cords at plugs, convenience receptacles, and the point where they exit from the product.
- Outdoor Antenna Grounding – If an outside antenna or cable system is connected to the product, be sure the antenna or cable system is grounded so as to provide some protection against voltage surges and built-up static charges. Article 810 of the National Electrical Code, ANSI/NFPA 70, provides information with regard to proper grounding of the mast and supporting structure, grounding of the lead-in wire to an antenna discharge unit, size of grounding conductors, location of antenna-discharge unit, connection to grounding electrodes, and requirements for the grounding electrode. See Figure A.
- Lightning – For added protection for this product during a lightning storm, or when it is left unattended and unused for long periods of time, unplug it from the wall outlet and disconnect the antenna or cable system. This will prevent damage to the product due to lightning and power-line surges.
- Power Lines – An outside antenna system should not be located in the vicinity of overhead power lines or other electric light or power circuits, or where it can fall into such power lines or circuits. When installing an outside antenna system, extreme care should be taken to keep from touching such power lines or circuits as contact with them might be fatal.
- Overloading – Do not overload wall outlets, extension cords, or integral convenience receptacles as this can result in a risk of fire or electric shock.
- Object and Liquid Entry – Never push objects of any kind into this product through openings as they may touch dangerous voltage points or short-out parts that could result in a fire or electric shock. Never spill liquid of any kind on the product.
- Servicing – Do not attempt to service this product yourself as opening or removing covers may expose you to dangerous voltage or other hazards. Refer all servicing to qualified service personnel.
- Damage Requiring Service – Unplug this product from the wall outlet and refer servicing to qualified service personnel under the following conditions:
 - When the power-supply cord or plug is damaged,
 - If liquid has been spilled, or objects have fallen into the product,
 - If the product has been exposed to rain or water,
 - If the product does not operate normally by following the operating instructions. Adjust only those controls that are covered by the operating instructions as an improper adjustment of other controls may result in damage and will often require extensive work by a qualified technician to restore the product to its normal operation,
 - If the product has been dropped or damaged in any way, and
 - When the product exhibits a distinct change in performance – this indicates a need for service.
- Replacement Parts – When replacement parts are required, be sure the service technician has used replacement parts specified by the manufacturer or have the same characteristics as the original part. Unauthorized substitutions may result in fire, electric shock, or other hazards.
- Safety Check – Upon completion of any service or repairs to this product, ask the service technician to perform safety checks to determine that the product is in proper operating condition.
- Wall or Ceiling Mounting – The product should be mounted to a wall or ceiling only as recommended by the manufacturer.
- Heat – The product should be situated away from heat sources such as radiators, heat registers, stoves, or other products (including amplifiers) that produce heat.

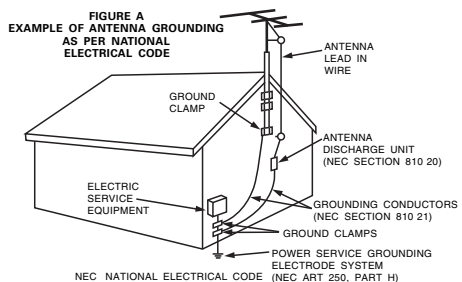

FCC Information (For US customers)

1. COMPLIANCE INFORMATION

Product Name: DVD Home Entertainment System

Model Number: S-302

This product contains FCC ID: BV2- MPGBR052.

This product complies with Part 15 of the FCC Rules. Operation is subject to the following two conditions: (1) this product may not cause harmful interference, and (2) this product must accept any interference received, including interference that may cause undesired operation.

Denon Electronics (USA), LLC
 100 Corporate Drive, Marwah, NJ 07430-2041
 Tel. 201-762-6500 (Main)

2. IMPORTANT NOTICE: DO NOT MODIFY THIS PRODUCT

This product, when installed as indicated in the instructions contained in this manual, meets FCC requirements. Modification not expressly approved by DENON may void your authority, granted by the FCC, to use the product.

3. CAUTION

- To comply with FCC RF exposure compliance requirement, separation distance of at least 20 cm must be maintained between the antenna of this product and all persons.
- This product and its antenna must not be co-located or operating in conjunction with any other antenna or transmitter.

4. NOTE

This product has been tested and found to comply with the limits for a Class B digital device, pursuant to Part 15 of the FCC Rules. These limits are designed to provide reasonable protection against harmful interference in a residential installation.

This product generates, uses and can radiate radio frequency energy and, if not installed and used in accordance with the instructions, may cause harmful interference to radio communications. However, there is no guarantee that interference will not occur in a particular installation. If this product does cause harmful interference to radio or television reception, which can be determined by turning the product OFF and ON, the user is encouraged to try to correct the interference by one or more of the following measures:

- Reorient or relocate the receiving antenna.
- Increase the separation between the equipment and receiver.
- Connect the product into an outlet on a circuit different from that to which the receiver is connected.
- Consult the local retailer authorized to distribute this type of product or an experienced radio/TV technician for help.

IC Information (For Canadian customers)

1. PRODUCT

This product contains IC 6963A-MPGBR052.

This product complies with RSS-210 of Industry Canada. Operation is subject to the following two conditions: (1) this product may not cause harmful interference, and (2) this product must accept any interference received, including interference that may cause undesired operation.

This Class B digital apparatus complies with Canadian ICES-003.

APPAREIL

Cet appareil contient IC 6963A- MPGBR052.

Cet appareil est conforme à la norme CNR-210 du Canada. L'utilisation de ce dispositif est autorisée seulement aux deux conditions suivantes : (1) il ne doit pas produire de brouillage, et (2) l'utilisateur du dispositif doit être prêt à accepter tout brouillage radioélectrique reçu, même si ce brouillage est susceptible de compromettre le fonctionnement du dispositif.

Cet appareil numérique de la classe B est conforme à la norme NMB-003 du Canada.







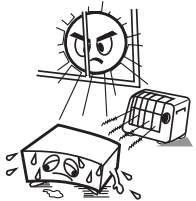

2. CAUTION

To reduce potential radio interference to other users, the antenna type and its gain should be so chosen that the equivalent isotropically radiated power (e.i.r.p.) is not more than that permitted for successful communication.

ATTENTION

Afin de réduire le risque d'interférence aux autres utilisateurs, il faut choisir le type d'antenne et son gain de façon à ce que la puissance isotrope rayonnée équivalente (p.i.r.e.) ne soit pas supérieure au niveau requis pour l'obtention d'une communication satisfaisante.

NOTE ON USE / OBSERVATIONS RELATIVES A L'UTILISATION

 <ul style="list-style-type: none"> • Avoid high temperatures. Allow for sufficient heat dispersion when installed in a rack. • Eviter des températures élevées. Tenir compte d'une dispersion de chaleur suffisante lors de l'installation sur une étagère. • Evite altas temperaturas. Permite la suficiente dispersión del calor cuando está instalado en la consola. 	 <ul style="list-style-type: none"> • Keep the unit free from moisture, water, and dust. • Protéger l'appareil contre l'humidité, l'eau et la poussière. • Mantenga el equipo libre de humedad, agua y polvo. 	 <ul style="list-style-type: none"> • Do not let foreign objects into the unit. • Ne pas laisser des objets étrangers dans l'appareil. • No deje objetos extraños dentro del equipo.
	 <ul style="list-style-type: none"> • Unplug the power cord when not using the unit for long periods of time. • Débrancher le cordon d'alimentation lorsque l'appareil n'est pas utilisé pendant de longues périodes. • Desconecte el cordón de energía cuando no utilice el equipo por mucho tiempo. 	 <ul style="list-style-type: none"> • Do not let insecticides, benzene, and thinner come in contact with the unit. • Ne pas mettre en contact des insecticides, du benzène et un diluant avec l'appareil. • No permita el contacto de insecticidas, gasolina y diluyentes con el equipo.
<ul style="list-style-type: none"> • Handle the power cord carefully. Hold the plug when unplugging the cord. • Manipuler le cordon d'alimentation avec précaution. Tenir la prise lors du débranchement du cordon. • Maneje el cordón de energía con cuidado. Sostenga el enchufe cuando desconecte el cordón de energía. 	 <p>* (For apparatuses with ventilation holes)</p> <ul style="list-style-type: none"> • Do not obstruct the ventilation holes. • Ne pas obstruer les trous d'aération. • No obstruya los orificios de ventilación. 	 <ul style="list-style-type: none"> • Never disassemble or modify the unit in any way. • Ne jamais démonter ou modifier l'appareil d'une manière ou d'une autre. • Nunca desarme o modifique el equipo de ninguna manera.

Contents

Getting Started

Accessories	2
Cautions on Handling	2
System Configuration	2
Cautions on Installation	3
Other Cautions.....	3
Discs	4
Discs usable on the S-302.....	4
Holding Discs.....	4
Loading Discs.....	4
Cautions on Loading Discs.....	5
Cautions on Handling.....	5
Cautions on Storing Discs.....	5
Cleaning Discs.....	5
About the Remote Control Unit	5
Inserting the Batteries.....	5
Operating Range of the Remote Control Unit.....	5
Part Names and Functions	6
Front Panel.....	6
Display.....	6
Rear Panel.....	7
Bottom Panel (Subwoofer).....	7
Remote Control Unit.....	8

Connections

Preparations	9
Cables Used for Connections.....	9
Video Conversion Function.....	10
Connecting the System	10, 11
Connecting the Monitor	11
Connecting Equipment with HDMI connectors	12
Connecting the Playback Components	12
Control Dock for iPod.....	12
Apple iPod Dock.....	13
TV Tuner.....	13
Satellite Receiver.....	13
Connections to Other Devices	13
USB Port.....	13
Antenna Terminals.....	14
External Controller.....	14
Network Audio.....	15
Once Connections are Completed	15

GUI Menu Operations

Example of the Display of the GUI Mark at a Title	16
Example of Display of Default Values	16
Examples of GUI Screen Displays	16
Example: Browse Menu (Top Menu).....	16
Example: During Playback (NET/USB).....	16
Cursor Position Display.....	16
Operations	17
GUI Menu Map	17

Setup

SETUP	18
1 Language.....	18
2 Video Setup.....	19
3 Audio Setup.....	19
4 Network Setup.....	20 ~ 22
5 Others.....	22
6 Timer.....	22, 23

Playback

Preparations	24
Turning the Power On.....	24
Loading Discs	24
Input source switching	24
Adjusting the Master Volume	24
Playing a DVD/Music CD Disc	25
Using the Top Menu/DVD Menu (DVD Video).....	25
Switching the Audio Language, Subtitle Language and Angle (DVD Video).....	26
Using the Playback Control Function (DVD Video).....	26
Playing Frame by Frame (DVD Video).....	26
Slow Playback (DVD Video).....	26
Playing in the Zoom Mode (DVD Video).....	26
Playing Repeatedly <Repeat playback> (DVD Video/Music CD).....	27
Playing Tracks in the Desired Order <Program> (Music CD).....	27
Playing Random Order <Random playback> (Music CD).....	27
Playing Music Files	
Before Playing MP3 or WMA Files.....	27
Creating MP3 and WMA Files Compatible with the S-302.....	27
Playing MP3 or WMA Files.....	27, 28

Playing Still Picture Files (JPEG format)	28
Creating JPEG Files Compatible on the S-302.....	28
Playing JPEG Files.....	29
Playing Picture CD/Fujicolor CD.....	29
Enjoying Surround Sound	29
Set the Input Mode.....	29
Selecting Surround Mode.....	30
Set the Surround Parameter.....	30
Playing Dolby Digital/DTS Multi-Channel Sources (Digital input only).....	31
Playing Dolby Digital/PCM/Analog 2-Channel Sources.....	31
Listening in the Dolby Headphone Mode.....	31
Listening to Radio Broadcasts	31
Tuning in Broadcast Stations.....	31, 32
Naming the Currently Tuned in Broadcast Station and Presetting it.....	32
Automatically Presetting FM Stations (Auto preset).....	32
Listening to Preset Stations.....	32
iPod® Playback	33
Listening to Music.....	33
Viewing Still Pictures (Only for iPods Equipped with the Photo Function).....	33
Disconnecting the iPod.....	33
Playing Network Audio or USB Memory Devices	34, 35
Basic Operation.....	35
Listening to Internet Radio.....	35, 36
Playing Files Stored on a Computer.....	36, 37
Playing Files Stored on USB Memory Devices.....	37
Playing a Portable Audio	37

Advanced Operation

Setting the Sleep Timer 38

Other Functions 38

 Adjusting the Tone 38

 Turning the Sound Off Temporarily (Muting) 38

Convenient Functions 39

 Personal Memory Plus Function 39

 Last Function Memory 39

 Backup Memory 39

 Auto Power On 39

 Resetting the Microprocessor 39

Remote Control Unit Operations

 Setting the preset memory function 40

 Operating a component stored in the preset memory 40

 Setting the punch through function 40, 41

Other Information 42 ~ 45

Troubleshooting 46 ~ 49

Specifications 50

List of preset codes End of this manual

Getting Started

Thank you for purchasing this DENON product. To ensure proper operation, please read these owner's manual carefully before using the product.

After reading them, be sure to keep them for future reference.

Accessories

Check that the following parts are supplied with the product.

- ① Remote control (RC-1072) 1
- ② R6P/AA batteries 2
- ③ System cable (D-SUB25P) (Cord length: Approx. 10 ft/3 m) 1
- ④ Speaker cable (Cord length: Approx. 16 ft/5 m) 2
- ⑤ Video cable (Cord length: Approx. 5 ft/1.5 m) 1
- ⑥ AM loop antenna 1
- ⑦ FM indoor antenna 1
- ⑧ Speaker stand 2
- ⑨ Wall bracket 2
- ⑩ Screw 4
- ⑪ Hex wrench 1
- ⑫ Rod antenna for wireless LAN 1
- ⑬ Anti slip pads 4
- ⑭ Owner's manual (with Quick setup sheet) 1
- ⑮ Warranty (for North America model only) 1
- ⑯ Service station list 1

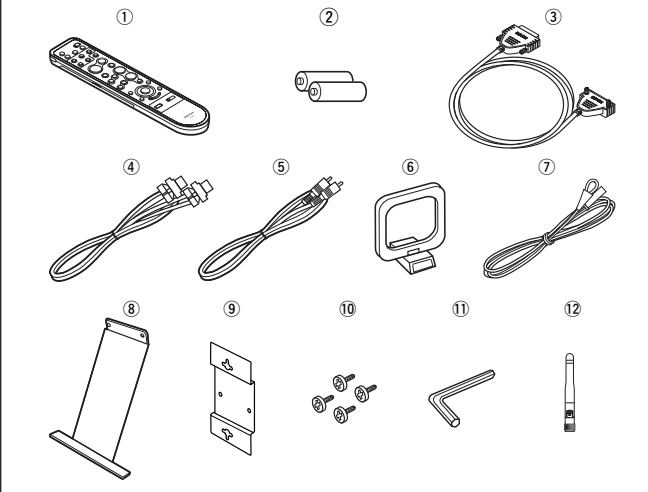

Cautions on Handling

- **Before turning the power switch on**
Check once again that all connections are correct and that there are no problems with the connection cables.
- Power is supplied to some of the circuitry even when the unit is set to the standby mode. When traveling or leaving home for long periods of time, be sure to unplug the power cord from the power outlet.
- **Sufficiently ventilate the place of installation**
If the unit is left in a room full of the smoke from cigarettes, etc., for long periods of time, the surface of the optical pickup could get dirty, in which case it will not be able to read the signals properly.
- **About condensation**
If there is a major difference in temperature between the inside of the unit and the surroundings, condensation (dew) may form on the operating parts inside the unit, causing the unit not to operate properly.
If this happens, let the unit sit for an hour or two with the power turned off and wait until there is little difference in temperature before using the unit.
- **Cautions on using mobile phones**
Using a mobile phone near this unit may result in noise. If so, move the mobile phone away from this unit when it is in use.
- **Moving the unit**
Turn off the power and unplug the power cord from the power outlet.
Next, disconnect the connection cables to other system units before moving the unit.
- Note that the illustrations in these instructions may differ from the actual unit for explanation purposes.

System Configuration

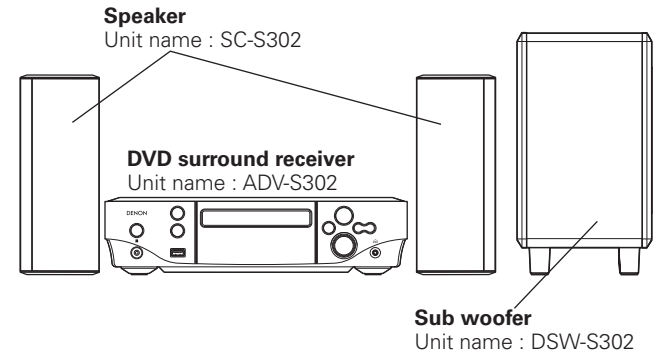

Cautions on Installation

Note:

For proper heat dispersal, do not install this unit in a confined space, such as a bookcase or similar enclosure.

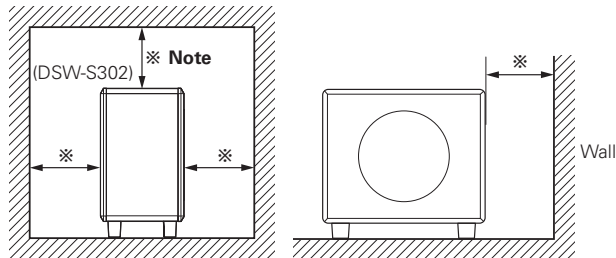
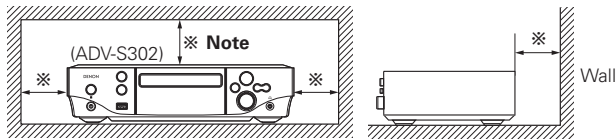

- ◎ The quality of the sound produced from the speaker is affected by the size and type of the room, as well as by the method of installation. Consider the points listed below before installing the speaker.
 - Placing speakers on the same stand or shelf as the record player could result in howling.
 - If there is a wall, glass door, etc., behind or to the sides of the speakers, resonance and reflections can be prevented by using a thick curtain, etc.
 - The speakers are of the shielded type. With some TVs, however, placing the speakers near the TV could cause color blotching on the TV's picture. If this happens, turn the TV's power off, move it away, wait 15 to 30 minutes, then turn the TV's power back on. If the color blotching persists, move the speakers further away.
 - Mount on a wall sufficiently sturdy to bear the weight of the speaker. Note that DENON will except no responsibility whatsoever for damages or accidents caused by the speaker falling.
 - To ensure safety, have a specialist install the speakers on the wall.
 - Be sure to fasten the speaker connection cables to the wall, etc., so that you do not get your feet or hands caught in them, causing the set to fall.
 - Place the subwoofer on a flat floor to prevent accidents due to the subwoofer tipping over.
 - Do not place a record player, CD player or other such device on top of the subwoofer.
 - Do not set the subwoofer with the baffle surface against the floor. Doing so will prevent you from achieving satisfactory sound effects.

CAUTION

- Be sure to fasten the speaker cords to a wall, etc., to prevent people from tripping over them or otherwise pulling on them accidentally, causing the speaker systems to fall.
- Be sure to check for safety after installing the speaker systems. Afterwards, perform safety inspections at regular intervals to be sure there is no danger that the speaker systems will fall. DENON will accept no responsibility for damages or accidents caused by inappropriate choice of the place of installation or improper installation procedures.



Other Cautions

- Switching the input function when input terminals are not connected. A clicking noise may be produced if the input function is switched when nothing is connected to the input terminals. If this happens, either turn down the VOLUME control knob or connect components to the input terminals.
- When watching TV broadcasts with the S-302's power turned on, depending on the conditions of the TV broadcast's signals, striped patterns may appear on the picture. This is not a malfunction of the S-302 or the TV. Turn the S-302's power off when watching TV.
- Note that if a magnet or a piece of furniture or equipment using magnets is placed nearby, interaction with the S-302 could result in color blotching on the TV.

NOTE

- This product uses a semiconductor laser. To ensure stable operation, it is recommended to use the product indoors at a temperature of 5 °C (41 °F) ~ 35 °C (95 °F).

Discs

Discs usable on the S-302

Usable discs	Mark (logo)	Recorded Signals	Disc size
DVD video		Digital audio + Digital video (MPEG2)	12cm
DVD-R/DVD+R (* 1) (* 2)	 		
DVD-RW/DVD+RW (* 1) (* 3)	 		
CD			
CD-R (* 4)		Digital audio MP3 Digital picture (JPEG)	12cm / 8cm
CD-RW (* 4)			
Picture CD		Digital picture (JPEG)	12cm
Fujicolor CD		Digital picture (JPEG)	12cm
WMA		Digital audio	12cm



* Playing discs with special shapes could damage the set. Do not use such discs.

*1 : DVD ± R/DVD ±RW discs recorded on a DVD recorder in the video mode and finalized can be played on the S-302.

Note, however, that in some cases the discs may not play properly, depending on their recording conditions.

Discs that have not been finalized or DVD ± R/DVD ±RW discs recorded in the VR mode or in CPRM cannot be played.

*2 : DVD+R DL.(Dual Layer) cannot be played.

*3 : DVD-RW discs recorded in the VR mode and finalized can be played.

*4 : According to recording quality, some CD-R/RW cannot be played.

CD-R/CD-RW discs recorded and finalized can be played on the S-302.



The following types of discs cannot be played on the S-302:

- DVD videos with region numbers other than "1" or "ALL"
- DVD-ROM/RAM
- CD-ROMs (Only JPEG / MP3 / WMA)
- VSDs / CVD /SVCD/Video CD
- CDV (only the audio portion can be played)
- CD-Gs (only the audio portion can be played)
- Photo CDs (NEVER play such discs on the S-302)

NOTE

DVD players and DVD video discs have region numbers (numbers assigned for different regions of the world).

The numbers must match or the discs cannot be played.

The Region number for this DVD video player is **1**.



NOTE

• Recordings you have made should only be used for your personal enjoyment, and as per copyright laws may not be used in other ways without permission of the copyright holder.

• Do not play CD-R/CD-RW discs containing files in formats other than music CD (CD-DA format), MP3, WMA or JPEG. Depending on the type of file, the set may malfunction or be damaged.

Holding Discs

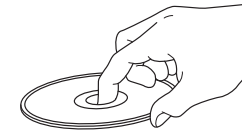

Do not touch the signal surface.

Loading Discs

- Set the disc with the labeled side facing up.
- Make sure the disc tray is fully open when inserting the disc.
- Place the discs flatly, 12 cm discs in the outer tray guide (Figure 1), 8 cm discs in the inner tray guide (Figure 2).

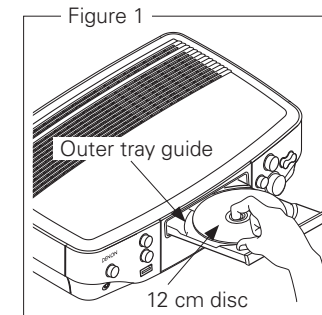

Figure 1

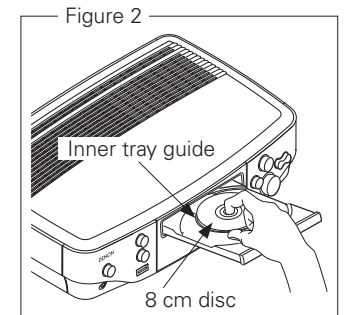

Figure 2

- Place 8 cm discs in the inner tray guide without using an adapter.



- "STOP" is displayed if a disc that cannot be played is loaded.
- "0h00m00s" is displayed if the disc is loaded upside-down or if no disc is loaded.

NOTE

Do not push the disc tray in by hand when the power is turned off. Doing so could damage the set.

Cautions on Loading Discs

- Only load one disc at a time. Loading two or more discs can damage the unit or scratch the discs.
- Do not use cracked or warped discs or discs that have been repaired with adhesive, etc.
- Do not use discs on which the sticky part of cellophane tape or labels is exposed or on which there are traces of where labels have been removed. Such discs can get caught inside the player and damage it.

Cautions on Handling

- Do not get fingerprints, oil or dirt on discs.
- Take special care not to scratch discs when removing them from their cases.
- Do not bend or heat discs.
- Do not enlarge the hole at the center.
- Do not write on the labeled (printed) surface with ball-point pens, pencils, etc., or stick new labels on discs.
- Water droplets may form on discs if they are moved suddenly from a cold place (outdoors for example) to a warm place, but do not try to dry them off using a hairdryer, etc.

Cautions on Storing Discs

- Be sure to remove discs after using them.
- Be sure to store discs in their cases to protect them from dust, scratches, warping, etc.
- Do not store discs in the following places:
 1. Places exposed to direct sunlight for long periods of time
 2. Dusty or humid places
 3. Places exposed to heat from heating appliances, etc.

Cleaning Discs

- If there are fingerprints or dirt on discs, wipe them off before using the disc. Fingerprints and dirt can impair sound quality and cause interruptions in playback.
- Use a commercially available disc cleaning set or a soft cloth to clean discs.

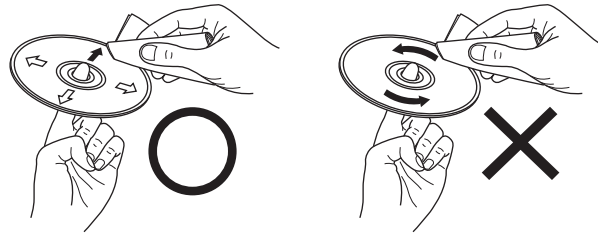

Gently wipe the disc from the inside towards the outside.

Do not wipe with a circular motion.

NOTE

Do not use record spray, antistatic agents, or benzene, thinner or other solvents.

About the Remote Control Unit

Inserting the Batteries

- ① Slide the rear lid in the direction of the arrow and remove it.
- ② Load the two batteries properly as indicated by the marks in the battery compartment.

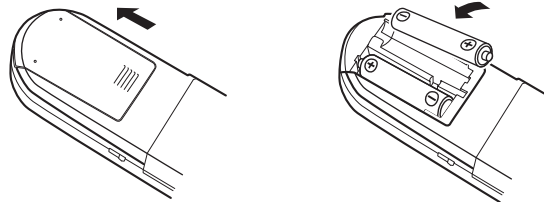

- ③ Put the rear cover back on.

NOTE

- Replace the batteries with new ones if the set does not operate even when the remote control unit is operated close to the unit.
- The supplied batteries are only for verifying operation.
- When inserting the batteries, be sure to do so in the proper direction, following the “⊕” and “⊖” marks in the battery compartment.
- To prevent damage or leakage of battery fluid:
 - Do not use a new battery together with an old one.
 - Do not use two different types of batteries.
 - Do not attempt to charge dry batteries.
 - Do not short-circuit, disassemble, heat or dispose of batteries in flames.
- If the battery fluid should leak, carefully wipe the fluid off the inside of the battery compartment and insert new batteries.
- Remove the batteries from the remote control unit if it will not be in use for long periods.
- When replacing the batteries, have the new batteries ready and insert them as quickly as possible.

Operating Range of the Remote Control Unit

Point the remote control unit at the remote sensor when operating it.

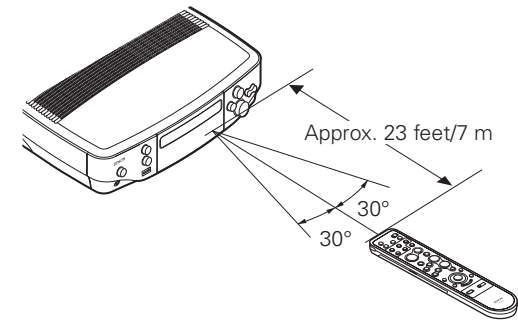

NOTE

The set may function improperly or the remote control unit may not operate if the remote control sensor is exposed to direct sunlight, strong artificial light from an inverter type fluorescent lamp or infrared light.

Part Names and Functions

For buttons not explained here, see the page indicated in parentheses ().

Front Panel

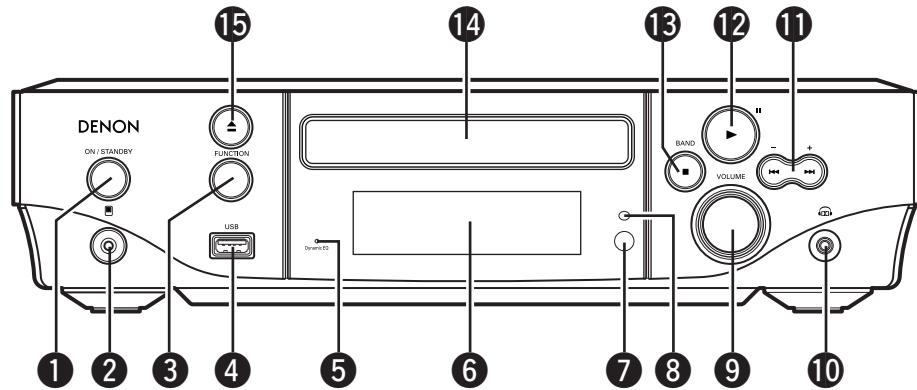

- 1 Power operation button (ON/STANDBY) (24)
- 2 Portable jack (37)
- 3 FUNCTION button (24)
- 4 USB port (13)
- 5 Audyssey Dynamic EQ indicators (44)
- 6 Display
- 7 Remote control sensor (5)
- 8 Dimmer sensor (22)
- 9 VOLUME control knob (24)
- 10 Headphones jack (31)
- 11 Skip buttons (|◀◀, ▶▶|) (25)
Tuning/Preset buttons (+, -) (31)
- 12 Play/Pause button (▶ ||) (25)
- 13 Stop/band button (■ BAND) (25, 31)
- 14 Disc tray (4)
- 15 Disc tray open/close button (▲) (4)

Display

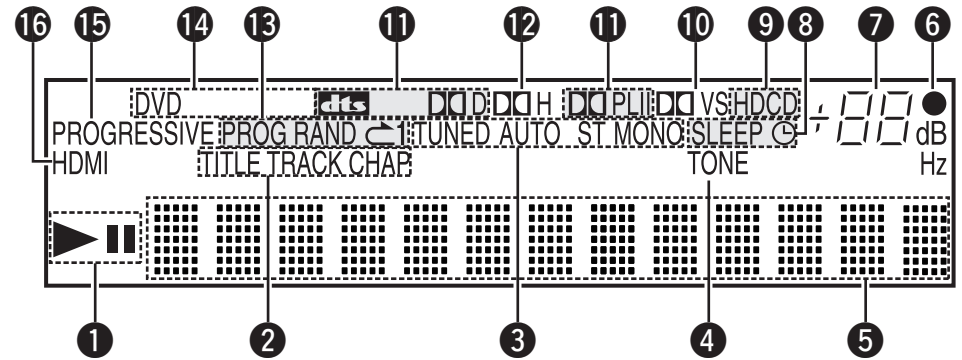

- 1 ▶ (the play indicator) lights when a disc is playing, and || (the pause mode) is set.
- 2 Disc section indicator (25)
- 3 Reception mode indicator (31)
- 4 Tone indicator (38)
- 5 Information display
Various information is displayed here, depending on the operation mode.
- 6 Remote control signal reception indicator (5)
- 7 Master volume indicator (24)
- 8 Timer indicator (38)
- 9 HDCD indicator (44)
- 10 Dolby Virtual Speaker mode indicator (31)
- 11 Input signal indicators (31)
- 12 Dolby Headphone mode indicator (31)
- 13 Play mode indicator (27, 28)
- 14 Disc indicator (4)
- 15 Progressive output indicator (11)
- 16 HDMI output indicator (12)

Rear Panel

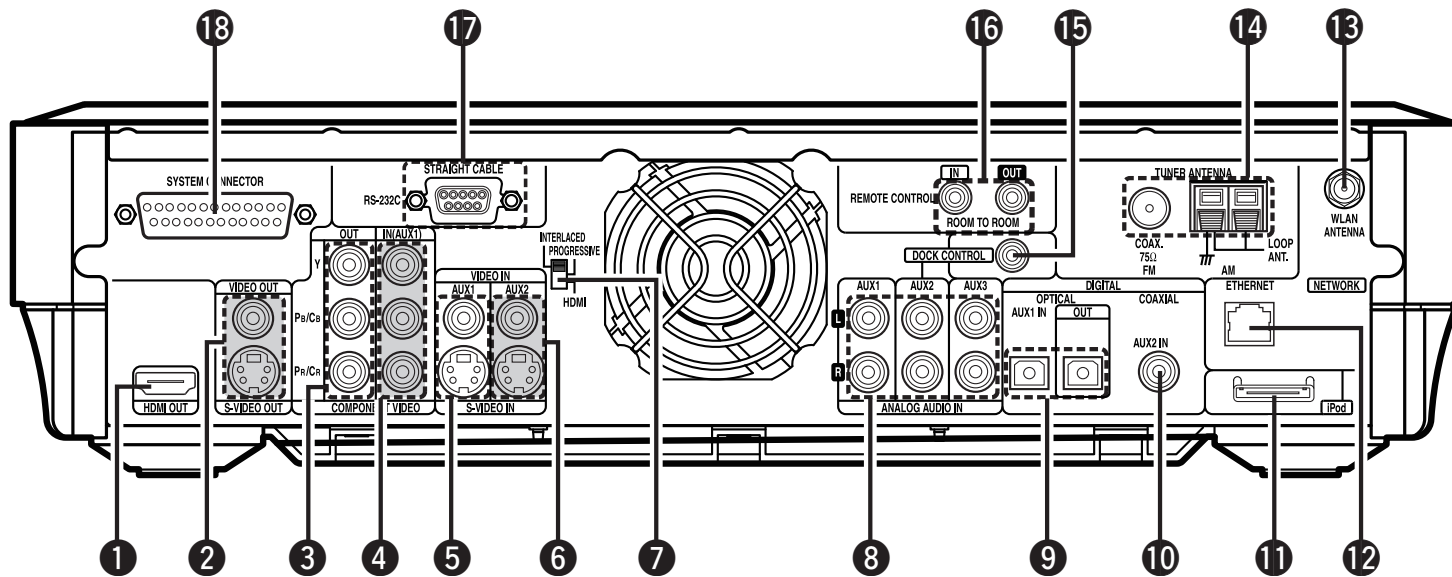

- 1 HDMI connectors (HDMI OUT) (11)
- 2 VIDEO / S-VIDEO connectors (VIDEO/S-VIDEO OUT) (11)
- 3 COMPONENT VIDEO connectors (COMPONENT VIDEO OUT) (11)
- 4 AUX1 COMPONENT VIDEO connectors (COMPONENT VIDEO IN) (13)
- 5 AUX1 VIDEO / S-VIDEO connectors (VIDEO/S-VIDEO IN) (13)
- 6 AUX2 VIDEO / S-VIDEO connectors (VIDEO/S-VIDEO IN) (12)
- 7 Video output selector switch (HDMI/PROGRESSIVE/INTERLACED) (11)
- 8 AUX1 / AUX2 / AUX3 Analog audio connectors (ANALOG AUDIO IN) (13)
- 9 AUX1 Digital audio connectors (OPTICAL DIGITAL IN/OUT) (13)
- 10 AUX2 Digital audio connectors (COAXIAL DIGITAL IN) (13)
- 11 iPod connector (12)
- 12 ETHERNET connector (15)
- 13 WLAN ANTENNA terminal (15)
- 14 FM/AM antenna terminals (ANTENNA) (14)
- 15 DOCK CONTROL jack (12)
- 16 REMOTE CONTROL jack (14)
- 17 RS-232C connector (14)
- 18 SYSTEM connector (SYSTEM CONNECTOR) (10)

Bottom Panel (Subwoofer)

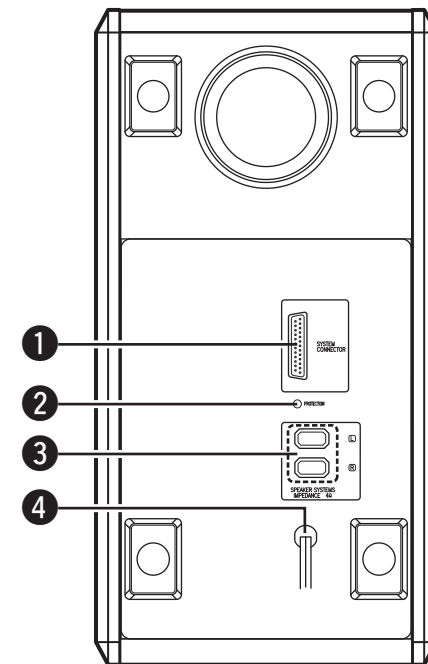

- 1 SYSTEM connector (10)
- 2 PROTECT indicator (46)
- 3 SPEAKER SYSTEMS connector (10)
- 4 Power cord (10)

Remote Control Unit

Front

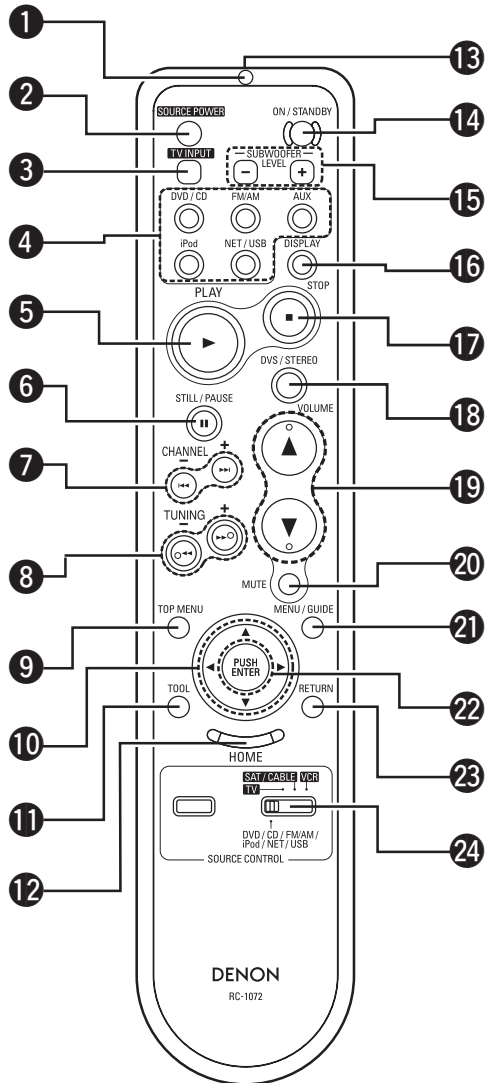

- 1 Signal transmission indicator (40)
- 2 External device power button (41)
- 3 TV input selector button (41)
- 4 Function button (24)
- 5 PLAY (▶) button (25)
- 6 STILL/PAUSE (⏏) button (25)
- 7 SKIP (◀◀, ▶▶) buttons (25)
- 8 SEARCH (◀◀, ▶▶) buttons (25)
- 9 TOP MENU button (25)
- 10 Cursor buttons (Δ▽◀▶) (25)
- 11 TOOL button
- 12 HOME button (17)
- 13 Remote control signal transmitter (5)
- 14 ON/STANDBY button (24)
- 15 SUB WOOFER LEVEL button
Adjust the subwoofer volume level.
- 16 DISPLAY button (27)
- 17 STOP (■) button (25)
- 18 Dolby virtual speaker/STEREO button (31)
- 19 Master volume control buttons (VOLUME) (24)
- 20 Muting button (MUTE) (38)
- 21 MENU/GUIDE button (25)
- 22 ENTER button (26)
- 23 RETURN button (26)
- 24 SOURCE CONTROL switch (40)
* To operate the S-302, set to the "DVD / CD / FM/AM / iPod / NET/USB" position.

Rear

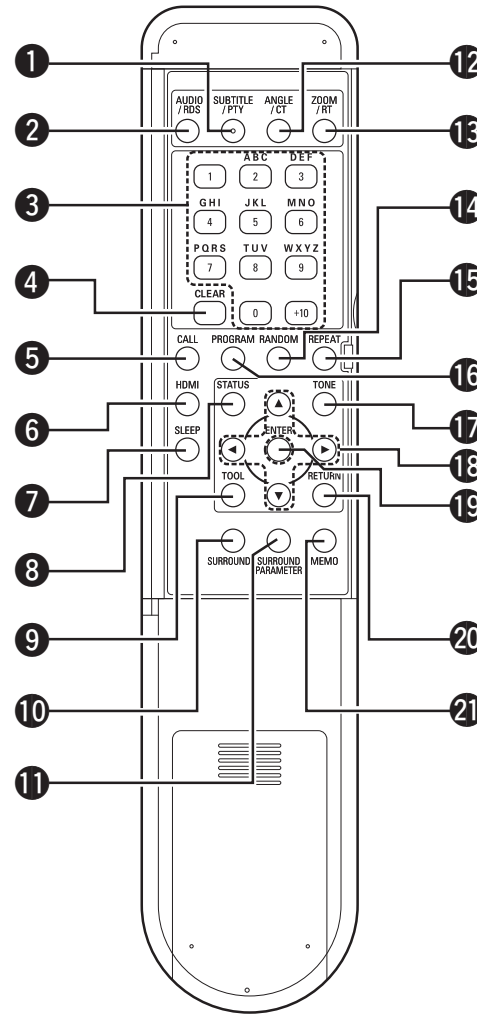

- 1 SUBTITLE/PTY button (26)
- 2 AUDIO/RDS button (26)
- 3 Character/Number (25, 32)
- 4 CLEAR button (27)
- 5 CALL button (27)
- 6 HDMI button (12)
- 7 SLEEP button (38)
- 8 STATUS button (31)
- 9 TOOL button
- 10 SURROUND button (30)
- 11 SURROUND PARAMETER button (30)
- 12 ANGLE/CT button (26)
- 13 ZOOM/RT button (26)
- 14 RANDOM button (27)
- 15 REPEAT button (27)
- 16 PROGRAM button (27)
- 17 TONE button (38)
- 18 Cursor buttons (Δ▽◀▶) (25)
- 19 ENTER button (26)
- 20 RETURN button (26)
- 21 MEMO button (32)

NOTE
The **TOOL** button cannot be used.

NOTE

- The **TOOL** button cannot be used.
- If buttons on the front or rear are pressed strongly, the button on the opposite side will be activated too.

Getting Started
Connections
Setup
Playback
Remote Control
Information
Troubleshooting

Connections

Connections for all compatible audio and video signal formats are described in these operating instructions. Please select the types of connections suited for the equipment you are connecting. With some types of connections, certain settings must be made on the S-302. For details, refer to the instructions for the respective connection items below.

NOTE

- Do not plug in the power supply cord until all connections have been completed.
- When making connections, also refer to the owner's manual of the other components.
- Be sure to connect the left and right channels properly (left with left, right with right).
- Do not bundle power supply cords together with connection cables. Doing so can result in humming or noise.

To change the speaker cable

Refer to the procedure below if you want to switch to a different speaker cable. This example describes how to mount the "+" side cable to the connector. Mount the "-" side cable in the same way.

1 Insert the included hexagonal wrench into the hole at the side of the connector's "+" side. (Arrow A)

2 Turn the hexagonal wrench in the direction of arrow B to loosen the cable.

3 Pull out the old cable. (Arrow C)

※ Be careful not to leave any broken wire parts inside the connector.

4 Peel off the cable's sheath and insert the new cable. (Arrow D)

5 Turn the hexagonal wrench in the direction of Arrow E and tighten securely so that the cable cannot be pulled out.

※ If the polarities are inverted, the phase may be off and the bass sound may be missing, resulting in an unnatural sound.

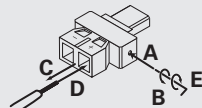

Preparations

Cables Used for Connections

Select the cables according to the equipment being connected.

Audio cables	Video cables
<p>Coaxial digital connections (Orange) Coaxial digital (75Ω / ohms pin-plug) cable</p> <p>Optical digital connections Optical transmission cable</p> <p>Analog connections (stereo) (White) (Red) Stereo pin-plug cable</p> <p>Network connections (wired LAN) LAN cable</p>	<p>Component video connections (Green) (Blue) (Red) (Y) (PB/CB) (PR/CR) Component video cable</p> <p>S-Video connections S-Video cable</p> <p>Video connections (Yellow) 75Ω / ohms pin-plug video cable</p>
Audio and video cables	
<p>HDMI connections 19-pin HDMI cable</p>	
Signal direction	
<p>Audio signal: </p> <p>Video signal: </p>	

Video Conversion Function

- This function automatically converts various formats of video signals input to the S-302 into the format used to output the video signals from the S-302 to a TV.
- The S-302's video input/output circuitry is compatible with the following three types of video signals:
Analog video signals: Component video, S-Video and video

[Flow of video signals inside the S-302]

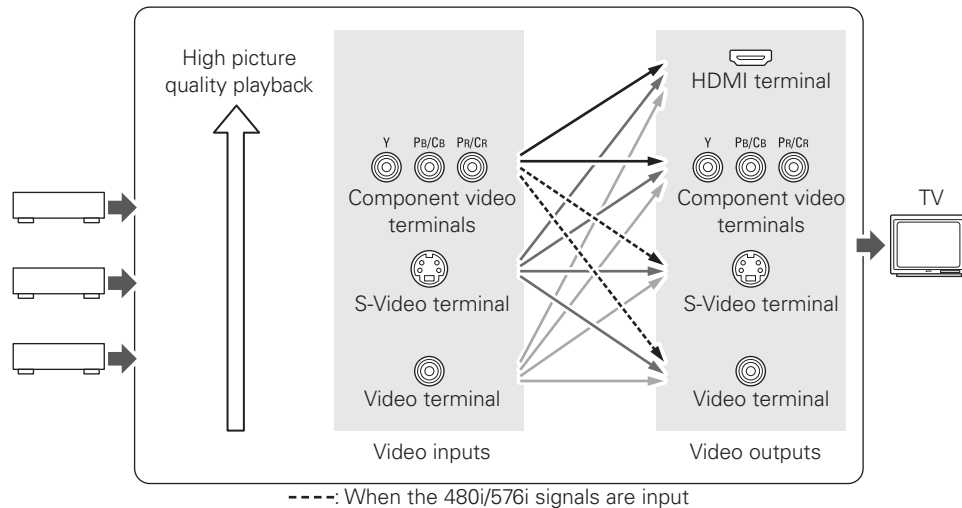

- When not using this function, output the signals to the TV using the same type of terminal as the video input terminal to which the signals are being input.
- The picture quality is not improved even if the video format to which the signal is converted using this function offers a high picture quality. The picture quality of the video signals output from the S-302 depends on the input signal.

NOTE

- 1080p component video input signals cannot be converted into other formats.
- 480p, 576p, 720p and 1080i component video input signals cannot be converted into S-Video or video format.

Connecting the System

A home theater can be achieved easily using the included cables to connect the DVD surround receiver (ADV-S302), subwoofer (DSW-S302), speakers (SC-S302) and your TV set.

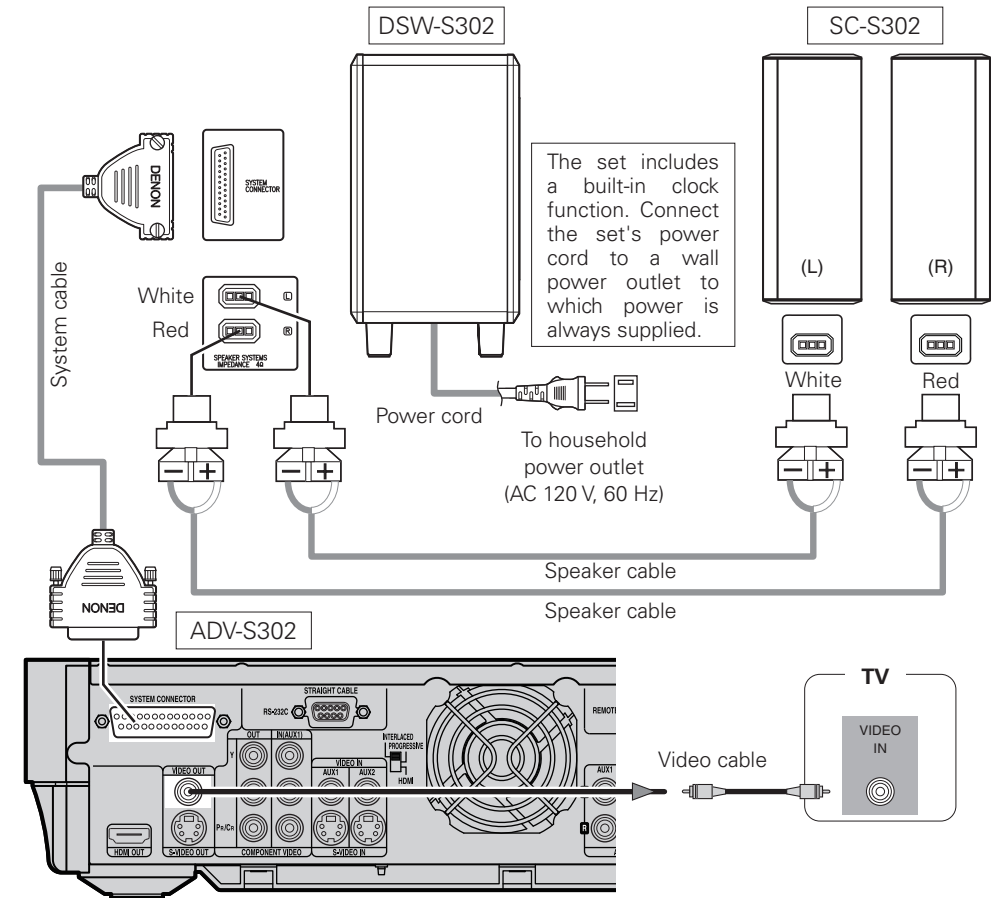

NOTE

- Connect the set's video output directly to the TV. Do not connect it via a VCR (video cassette recorder). Some discs contain copy prohibit signals, and the picture could be disturbed if such discs are played via a VCR.
- Insert the plugs securely. Incomplete connections will result in the generation of noise.
- Do not unplug the power cord while the set is operating.
- When connecting system cables and speaker cables, first lay them out sideways. When laying them out take care not to damage them.

Protector circuit

The protection circuit will be activated in the following cases:

- When the speaker output is short-circuited
- When the temperature around the set is extremely high
- When the set is used for long periods of time with a high output and the internal temperature rises

When the protection circuit is activated, the speaker output is cut off and the power indicator flashes. Should this occur, please follow these steps: be sure to switch off the power of this unit, check whether there are any faults with the wiring of the speaker cables or input cables, and wait for the unit to cool down if it is very hot. Improve the ventilation condition around the unit and switch the power back on.

If the protection circuit is activated again even though there are no problems with the wiring or the ventilation around the unit, switch off the power and contact a DENON service center.

Note on speaker impedance

If speakers with an impedance below the specified impedance (4 Ω/ohms) are used (for example, speakers with an impedance of 3 Ω/ohms) with the volume turned up high for long periods of time, the temperature may rise, activating the protective circuit.

When the protection circuit is activated, the output to the speakers is cut off and the power indicator blinks. If this happens, unplug the power supply cord, wait for the set to cool off and improve ventilation around the unit. Also check the wiring of the input cables and the speaker cables. After doing this, plug the power supply cord back in and turn the unit's power back on.

If the protection circuit is activated again even though there are no problems with the wiring or the ventilation around the unit, switch off the power and contact a DENON service center.

Mounting the speaker stand and bracket

- ※ Be sure to tighten the screws completely.
- ※ Also be careful when installing.

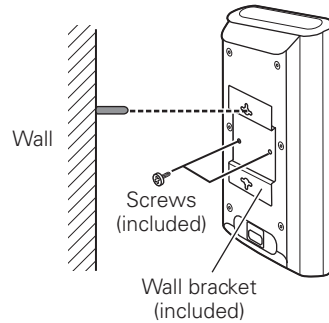
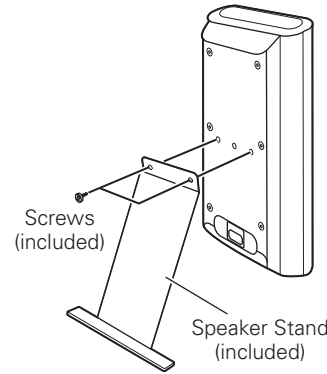

- ※ When placing the speaker system (SC-S302) on a stand, etc., stick the included cushion pads at the two corners of the bottom surface. (Refer to the illustration below.)

Connecting the Monitor

Select and connect using one of the video cables below according to the TV's terminals. The terminals provide playback with different picture qualities, in the following order (from highest to lowest): ①HDMI terminals, ②Component video terminals, ③S-Video terminals, ④Video terminals

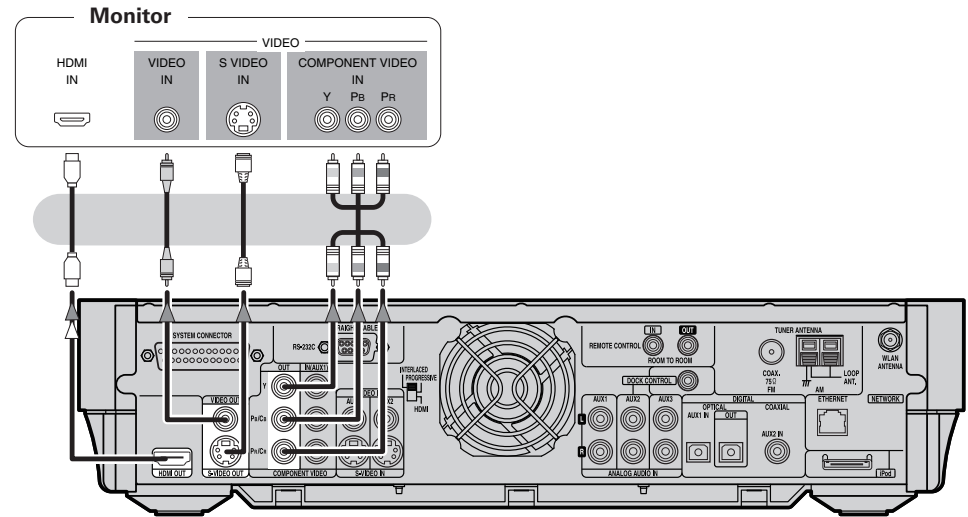

Switching the video output format

Set the **HDMI/PROGRESSIVE/INTERLACED** switch on the rear panel according to the video output format of the TV connected to the set.

- ※ Be sure to turn the power off before operating the switch.



The component video terminals may be indicated differently on your TV. For details, see the TV's operating instructions.

Connecting Equipment with HDMI Connectors

Digital video and digital audio can both be connected using a single HDMI cable.

NOTE

- When playing multichannel sources, the audio output is downmixed to two channels for output. In addition, the sampling frequency is lowered to 48 kHz.
- Video signals are not output properly when using devices that are not HDCP-compatible.
- Use a cable on which the HDMI logo is indicated (a certified HDMI product) for connection to the HDMI connector. Normal playback may not be possible when using a cable other than one on which the HDMI logo is indicated (a non-HDMI-certified product).
- The audio signals output from the HDMI connector (sampling frequency, bit rate, etc.) may be restricted by the connected device.



If the connected TV is only compatible with DVI-D terminals, use an HDMI/DVI conversion cable.

When connecting with an HDMI/DVI converter cable (adapter)

- HDMI video signals are theoretically compatible with the DVI format. When connecting to a TV, etc., equipped with a DVI-D terminal, connection is possible using an HDMI/DVI converter cable, but depending on the combination of components in some cases the video signals will not be output.
- When connecting using an HDMI/DVI converter adapter, the video signals may not be output properly due to poor connections with the connected cable, etc.

Condition of signals from the S-302's HDMI output terminal	HDMI-compatible monitor	DVI-D-compatible monitor (HDCP compatible)	DVI-D-compatible monitor (HDCP non compatible)
	Both video and audio output	Only video output *	Neither video nor audio output

*: Only output when video signals are of RGB format.

Copyright protection system

In order to play the digital video and audio signals of a DVD Video disc using HDMI connections, both the connected DVD player and TV must be equipped for a copyright protection system called "HDCP" (High-bandwidth Digital Content Protection).

HDCP is a copy protection technology consisting of data encoding and mutual identification of the devices. The S-302 is HDCP-compatible. Check the operating instructions of your TV to see if they are compatible.

Setting the HDMI output resolution

Set the resolution of the video signals output from the HDMI output terminal to a resolution with which the connected devices are compatible. Press **HDMI** on the remote control unit to select.

→ 480p/576p → 720p → 1080i → 1080p → AUTO

Connecting the Playback Components

Carefully check the left (L) and right (R) channels and the inputs and outputs, and be sure to interconnect correctly.

Control Dock for iPod

Use either a DENON Control Dock for iPod (ASD-1R, sold separately) or an iPod cable (AK-P100, sold separately) to connect the S-302 and an iPod.



- When using the Control Dock for iPod, certain settings must be made on the Control Dock for iPod. For details, refer to the Control Dock for iPod's operating instructions.
- When using an iPod, refer to "iPod® Playback" (page 33).

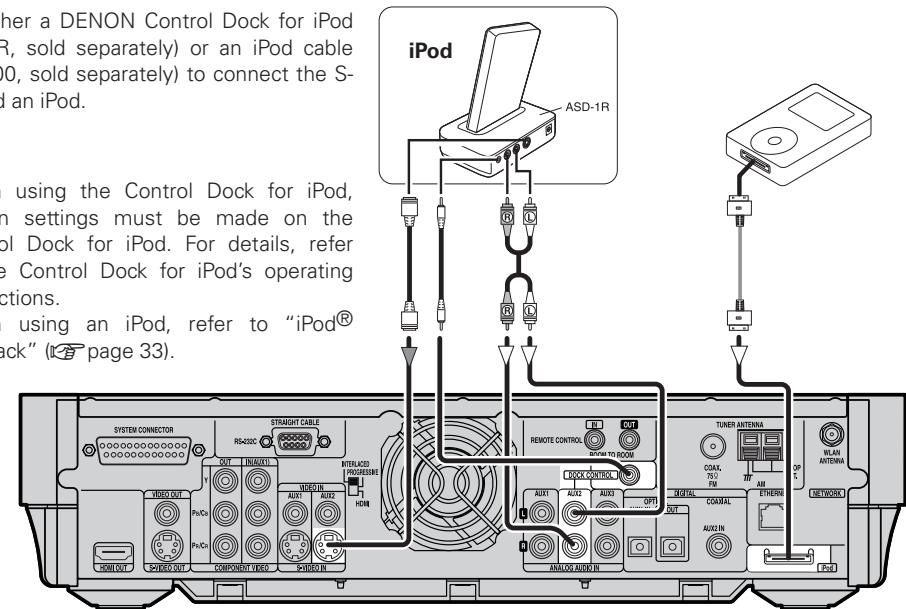

Apple iPod Dock



- When using an iPod, make the setting at GUI menu "SETUP" – "Others" – "iPod Assign".

The following iPod docks can be used with this method:

- iPod Dock M9868G/A (For iPod with color displays)
- iPod Dock MA072G/A (For iPod nanos)

iPod

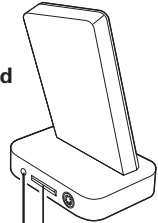

iPod Dock (Sold separately)

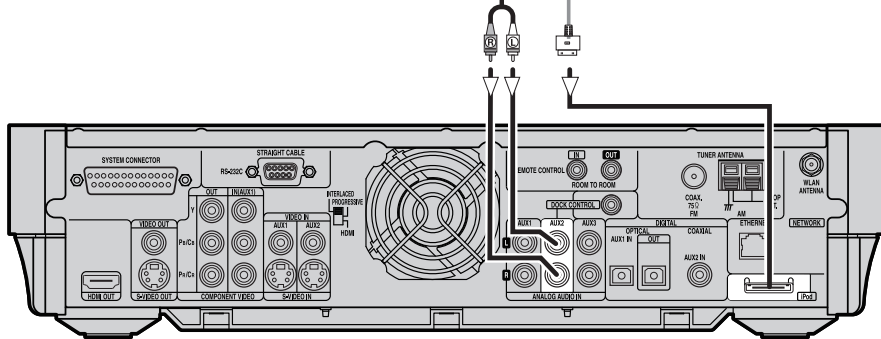

TV Tuner

Connect the cables to be used.

TV tuner

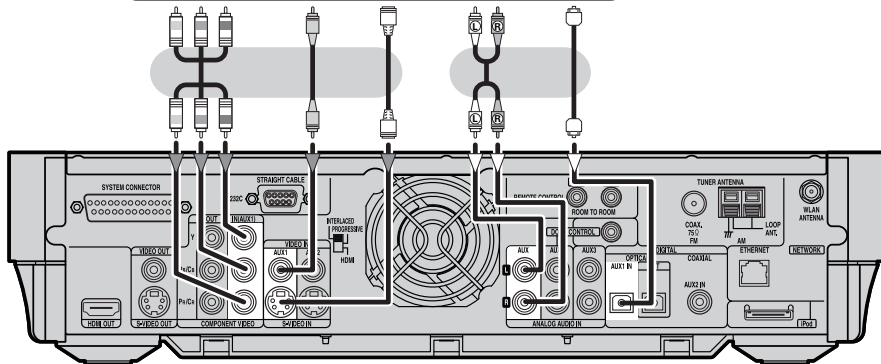
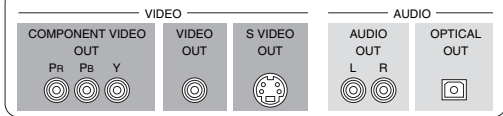

Satellite Receiver

Connect the cables to be used.

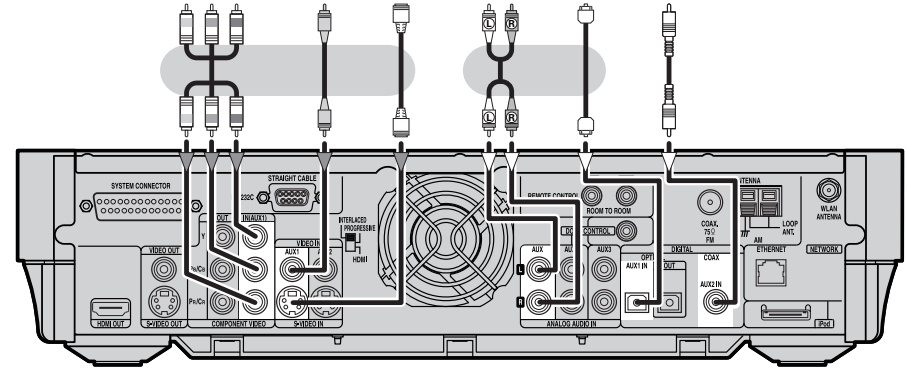
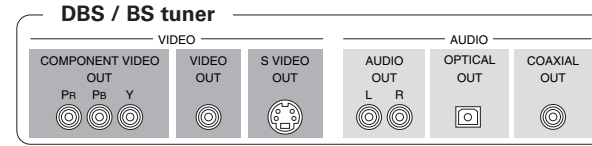

- When there are multiple input signals, the input signals are detected and the input signal to be output from the video monitor output terminal is selected automatically in the following order: S-Video, composite video.
- The S-302 is equipped with a function for up and down converting video signals (page 10).
- Connect to "OPT. AUX1" when using the OPTICAL terminal for the digital audio input, to "AUX2" when using the COAXIAL terminal.

Connections to Other Devices

USB Port

- Front panel

USB memory device

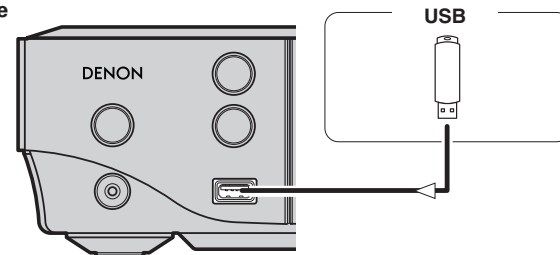

Antenna Terminals

An F-type FM antenna cable plug can be connected directly.

AM/FM

Direction of broadcasting station

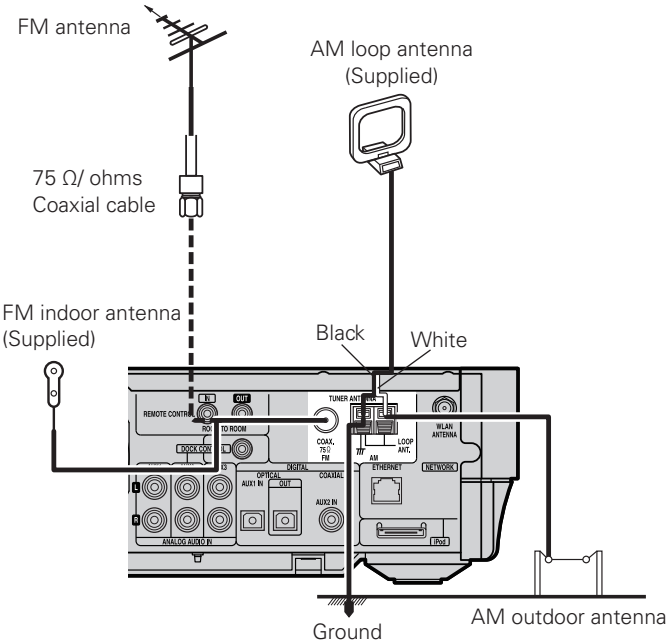

Note to CATV system installer:

This reminder is provided to call the CATV system installer's attention to Article 820-40 of the NEC which provides guidelines for proper grounding and, in particular, specifies that the cable ground shall be connected to the grounding system of the building, as close to the point of cable entry as practical.

AM loop antenna assembly

- ① Remove the vinyl tie and take out the connection line.
 - ② Connect to the AM antenna terminals.
 - ③ Bend in the reverse direction.
 - ④ Mount
 - a. With the antenna on top any stable surface.
 - b. With the antenna attached to a wall.
- Installation hole Mount on wall, etc.

Connection of AM antennas

1. Push the lever.
2. Insert the conductor.
3. Return the lever.



NOTE

- Do not connect two FM antennas simultaneously.
- Even if an external AM antenna is used, do not disconnect the AM loop antenna.
- Make sure the AM loop antenna lead terminals do not touch metal parts of the panel.

External Controller

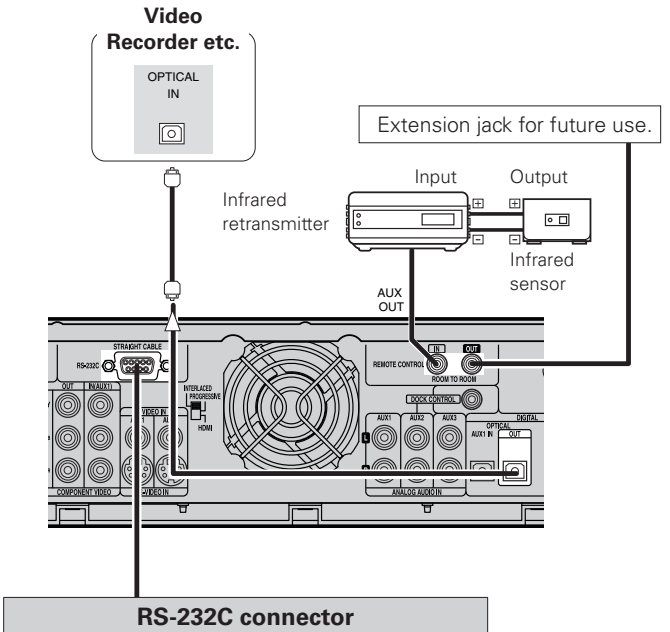

RS-232C connector

This connector is used for an external controller.

※ If you wish to control the S-302 from an external controller using the RS-232C connector, perform the operation below beforehand.

- ① Turn the S-302's power.
- ② Turn off the S-302's power from the external controller.
- ③ Check that the S-302 is in the standby mode.

Network Audio

[Wired LAN]

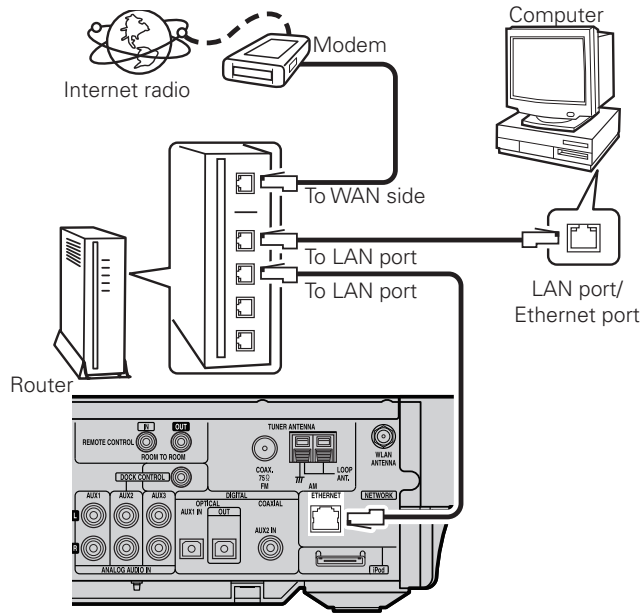

[Wireless LAN]

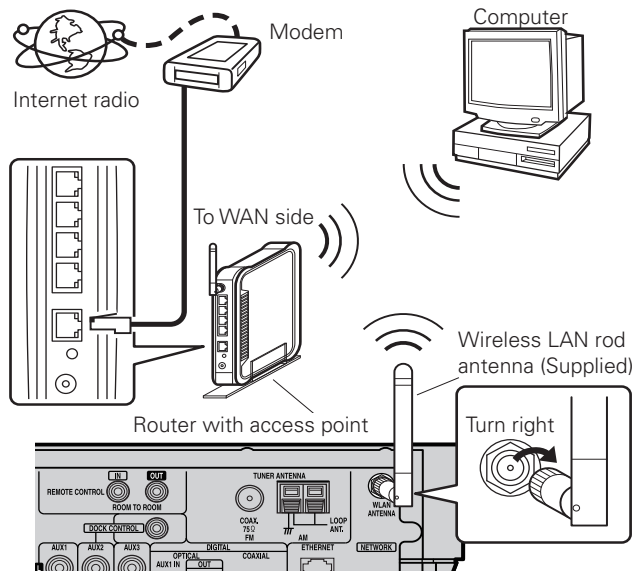

Required system

❑ Broadband Internet connection

A broadband line connection to the Internet is required in order to use the S-302's Internet radio function.

❑ Modem

This is a device that is connected to the broadband line to communicate with the Internet.

❑ Router

When using the S-302, we recommend you to use a router equipped with the following functions:

- Built-in DHCP (Dynamic Host Configuration Protocol) server
This function automatically assigns IP addresses on the LAN.
- Built-in 100 BASE-TX switch
When connecting multiple devices, we recommend a switching hub with a speed of 100 Mbps or greater.

❑ Ethernet cable (CAT-5 or greater recommended)

The S-302 does not come with an Ethernet cable. Purchase a cable of the required length.

❑ Computer

A computer with the following specifications is required to operate the music server:

- OS
Windows® XP Service Pack2, Windows Vista
- Software
.NET Framework 1.1, Windows Media Connect (Windows XP), Windows Media Player Ver.11
- Internet browser
Microsoft Internet Explorer 5.01 or later
- LAN port
- 300 MB or more free disk space

※Free space is required to save music files. The following sizes are approximate.

Format	Bit rate	Per minute	Per hour
MP3 / WMA	128kbps	Approx. 1 MB	Approx. 60 MB
	192kbps	Approx. 1.5 MB	Approx. 90 MB
	256kbps	Approx. 2 MB	Approx. 120 MB
WAV (LPCM)	392kbps	Approx. 3 MB	Approx. 180 MB
	1400kbps	Approx. 10 MB	Approx. 600 MB

(1MB = 10⁶ bytes)



- Depending on the server, video files may be displayed, but they cannot be played on the S-302.
- For connections to the Internet, contact an ISP (Internet Service Provider) or a computer shop.
- The types of routers that can be used depend on the ISP. Contact an ISP (Internet Service Provider) or a computer shop for details.

NOTE

A contract with an ISP is required to connect to the Internet. No additional contract is needed if you already have a broadband connection to the Internet.

❑ Others

- If you have an ISP contract for a line on which network settings are made manually, make the settings at "Network Setup" (page 20, 21).
- When using a broadband router (DHCP function), the S-302 makes the network settings automatically, so there is no need to make them yourself.
- If connecting the S-302 to a network with no DHCP function, make the settings at "Network Setup" (page 20, 21).
- The S-302 is not compatible with PPPoE. A PPPoE-compatible router is required if you have a contract for a line of the type with which the PPPoE is set.
- Depending on the ISP with which you have your contract, it may be necessary to make proxy server settings to use the Internet radio function. If you made proxy server settings on the computer to connect to the Internet, make the same proxy server settings on the S-302.
- The S-302 uses the DHCP and Auto IP functions to make the network settings automatically.

❑ Ethernet cable (CAT-5 or greater recommended)

No Ethernet cable is included with the S-302. Procure a cable with the necessary length.

NOTE

Be sure to use a shielded type cable for USB/Ethernet connections. Depending on the connected computer/router, there may be much noise generated from the cable.

Once Connections are Completed

Turning the Power On (page 24)

GUI Menu Operations

With the S-302, settings and operations for most functions can be performed by operating while looking at the GUI menu displayed on the monitor screen.

 The GUI cannot be superimposed when xvYCC signals, component 1080p signal and computer's resolution (e.g.VGA) are input.

Example of the Display of the GUI Mark at a Title

Items for which this mark is indicated at the title can be operated from the GUI.
We recommend performing such operations from the GUI.

SETUP
Make detailed settings for various parameters.



This is the GUI icon for this setting item or for the menu series to which this item belongs.

Example of Display of Default Values

In lists of selectable items or adjustable ranges, the item surrounded by a border is the default value.

[Selectable items] **English** Français Español Deutsch

Examples of GUI Screen Displays

Some typical examples are described below.

Example: Browse Menu (Top Menu)

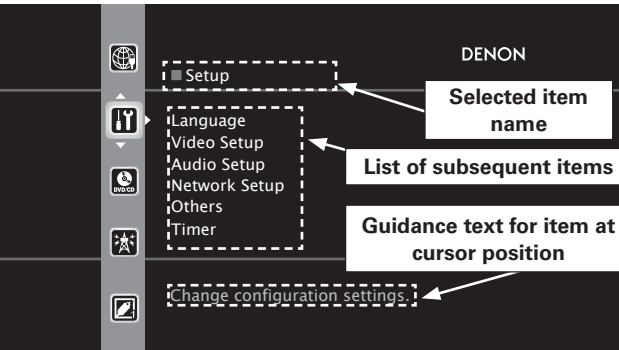

Selected item name (DENON)

List of subsequent items (Setup, Language, Video Setup, Audio Setup, Network Setup, Others, Timer)

Guidance text for item at cursor position (Change configuration settings)

Example: During Playback (NET/USB)

The playback options (repeat, random, etc.) are displayed.

The playback status is indicated with the icons shown below.
Play ▶, Pause ⏸, Stop ⏹, Manual search ⏮, ⏭

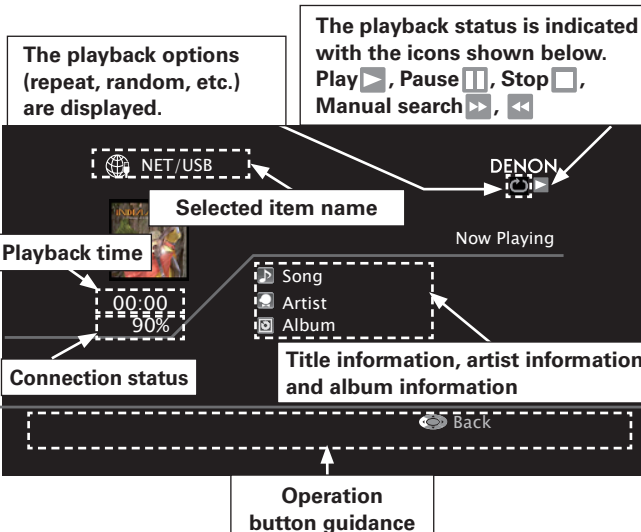

Selected item name (NET/USB)

Playback time (00:00 / 90%)

Connection status (NET/USB)

Title information, artist information and album information (Song, Artist, Album)

Operation button guidance (Back)

Cursor Position Display

Icon



Switch the selected item (up/down arrows)

Proceed to the next item (right arrow)

Selected item (center)

Switch the selected item (down arrow)

List

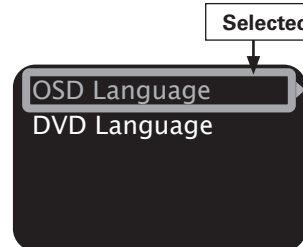

Selected item (highlighted)

Switch to the next item (right arrow)

※ Switch the selected item using Δ∇.

Operations

The same operation is possible on the remote control unit.

1 Press the HOME button.
The GUI menu is displayed.

2 Press the Δ ∇ \triangleright button to select the menu to be set or operated.
※ To return to the previous item, press the \triangleleft .

3 Press the ENTER or \triangleright button to enter the setting.

NOTE

Press the **HOME** button again to quit the GUI menu screen.

GUI Menu Map

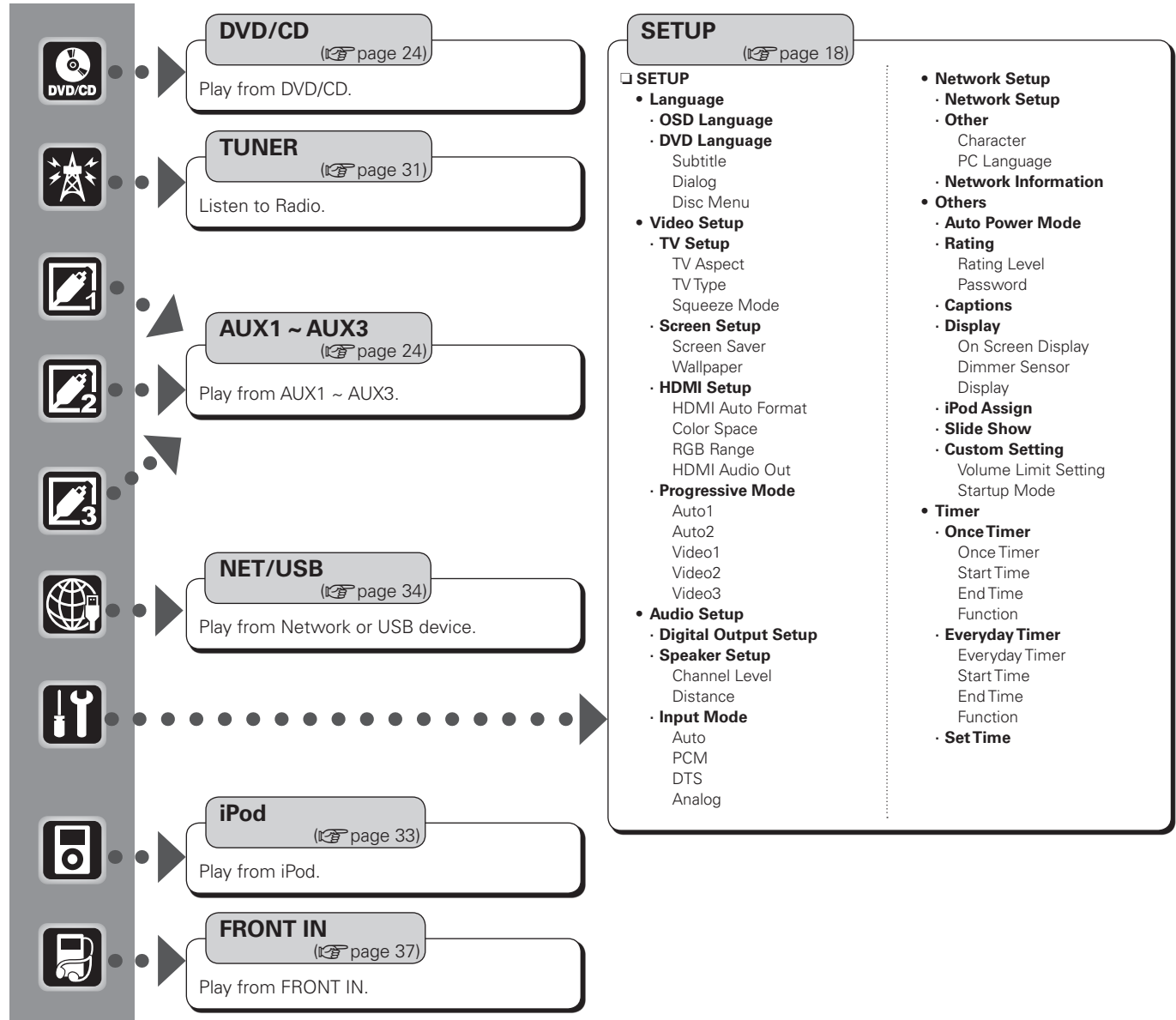

Setup

SETUP

Make detailed settings for various parameters.



● Menu tree ●

SETUP

1 Language

2 Video Setup

3 Audio Setup

4 Network Setup

5 Others

6 TIMER

1 Language

Make settings for GUI language, DVD subtitle/dialog language etc.

OSD Language

Select the language displayed on the GUI screen.

[Selectable items]

- English
- Deutsch
- Français
- Italiano
- Español
- Nederlands
- Svenska
- 日本語

DVD Language

Make language settings for DVD playback.

Subtitle

Select language for subtitles.

[Selectable items]

- English
- German
- French
- Italian
- Spanish
- Others
- Off
- Japanese

Dialog

Select language for dialog.

[Selectable items]

- English
- German
- French
- Italian
- Spanish
- Others
- Japanese

Disc Menu

Select disc menu language.

[Selectable items]

- English
- German
- French
- Italian
- Spanish
- Others
- Japanese



If "Other" was selected, refer to the "Language code list" and input the code number using the **NUMBER (0 ~ 9)** buttons.

Language code list

Code	Language	Code	Language	Code	Language	Code	Language
6565	Afar	7079	Faroese	7678	Lingala	8375	Slovak
6566	Abkhazian	7082	French	7679	Laothian	8376	Slovenian
6570	Afrikaans	7089	Frisian	7684	Lithuanian	8377	Samoaan
6577	Ameharic	7165	Irish	7686	Latvian, Lettish	8378	Shona
6582	Arabic	7168	Scots Gaelic	7771	Malagasy	8379	Somali
6583	Assamese	7176	Galician	7773	Maori	8381	Albanian
6589	Aymara	7178	Guarani	7775	Macedonish	8382	Serbian
6590	Azerbaijani	7185	Gujarati	7776	Malayalam	8385	Sundanese
6665	Bashkir	7265	Hausa	7778	Mongolian	8386	Swedish
6669	Byelorussian	7273	Hindi	7779	Moldavian	8387	Swahili
6671	Bulgarian	7282	Croatian	7782	Marathi	8465	Tamil
6672	Bihari	7285	Hungarian	7783	Malay	8469	Telugu
6678	Bengali; Bangla	7289	Armenian	7784	Maltese	8471	Tajik
6679	Tibetan	7365	Interlingua	7789	Burmese	8472	Thai
6682	Breton	7378	Indonesian	7865	Nauru	8473	Tigrinya
6765	Catalan	7383	Icelandic	7869	Nepali	8475	Turkmen
6779	Corsican	7384	Italian	7876	Dutch	8476	Tagalog
6783	Czech	7387	Hebrew	7879	Norwegian	8479	Tonga
6789	Welsh	7465	Japanese	7982	Oriya	8482	Turkish
6865	Danish	7473	Yiddish	8065	Panjabi	8484	Tatar
6869	German	7487	Javanese	8076	Polish	8487	Twi
6890	Bhutani	7565	Georgian	8083	Pashto, Pushto	8575	Ukrainian
6976	Greek	7575	Kazakh	8084	Portuguese	8582	Urdu
6978	English	7576	Greenlandic	8185	Quechua	8590	Uzbek
6979	Esperanto	7577	Cambodian	8277	Rhaeto-Romance	8673	Vietnamese
6983	Spanish	7578	Kannada	8279	Romanian	8679	Volapük
6984	Estonian	7579	Korean	8285	Russian	8779	Wolof
6985	Basque	7583	Kashmiri	8365	Sanskrit	8872	Xhosa
7065	Persian	7585	Kurdish	8368	Sindhi	8979	Yoruba
7073	Finnish	7589	Kirghiz	8372	Serbo-Croatian	9072	Chinese
7074	Fiji	7665	Latin	8373	Singhalese	9085	Zulu

2 Video Setup

Make video output settings to match connected monitor.

TV Setup

Make settings for aspect ratio, video signal format etc.

TV Aspect

Select monitor aspect ratio.

[Selectable items]

Wide (16:9) Normal (4:3LB) Normal (4:3PS)



With the "NORMAL (4:3PS)" setting, 16:9 pictures are displayed with the left and right sides cut off. Sources not compatible with panning and scanning are displayed with black bands at the top and bottom.

TV Type

Select video signal format for monitor.

[Selectable items] **NTSC** PAL Multi

Squeeze Mode

Select display method of 4:3 material on 16:9 screen.

[Selectable items] ON OFF



There is no effect with interlaced video outputs.

Screen Setup

Make GUI related settings.

Screen Saver

Use the screen saver to prevent burn-in on the monitor screen.

[Selectable items] ON OFF

Wallpaper

Change the GUI background.

[Selectable items] **Picture** Blue Gray Black

HDMI Setup

Make settings for HDMI video/audio output.

HDMI Auto Format

Make settings for resolution of HDMI video output signal.

Set the AUTO function selected with the remote control unit's **HDMI** button.

[Selectable items] **Panel Resolution** Max. Resolution

Color Space

Make settings for output color space.

[Selectable items] **YCbCr** RGB

RGB Range

Make settings for RGB output range.

[Selectable items] **Normal** Enhanced

HDMI Audio Out

Select whether to output audio via HDMI. (DVD only)

[Selectable items] ON OFF

Progressive Mode

Select optimum progressive mode for video material.

[Selectable items] **Auto1** Auto2 Video1 Video2 Video3

3 Audio Setup

Make settings for audio playback.

Digital Output Setup

Make settings for digital audio signal format.

[Selectable items] **Normal** PCM

Speaker Setup

Make detailed speaker settings.

Channel Level

Listening to the test tones at the listening position, adjust the level of the speakers for the different channels so that the volume level sounds the same from all speakers.

[Selectable items]

Test Tone Front Left Speaker Front Right Speaker Subwoofer



- The volume can be adjusted between the range of -12dB to +12dB.
- When "TESTTONE" is selected, the test tones are output in intervals of 4 seconds for the first two cycles, 2 seconds from the third cycle on, in the order shown below.

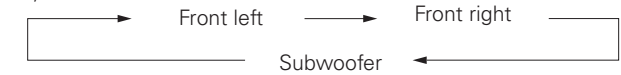

Distance

Set distance from listening position to speakers.

[Selectable items]

Distance Front Left Speaker Front Right Speaker Subwoofer

Default

Input Mode

Set the input mode for this source.

[Selectable items] **Auto** PCM DTS Analog

4 Network Setup

Make settings for wired or wireless LAN.

Wired LAN

Make settings for wired LAN.

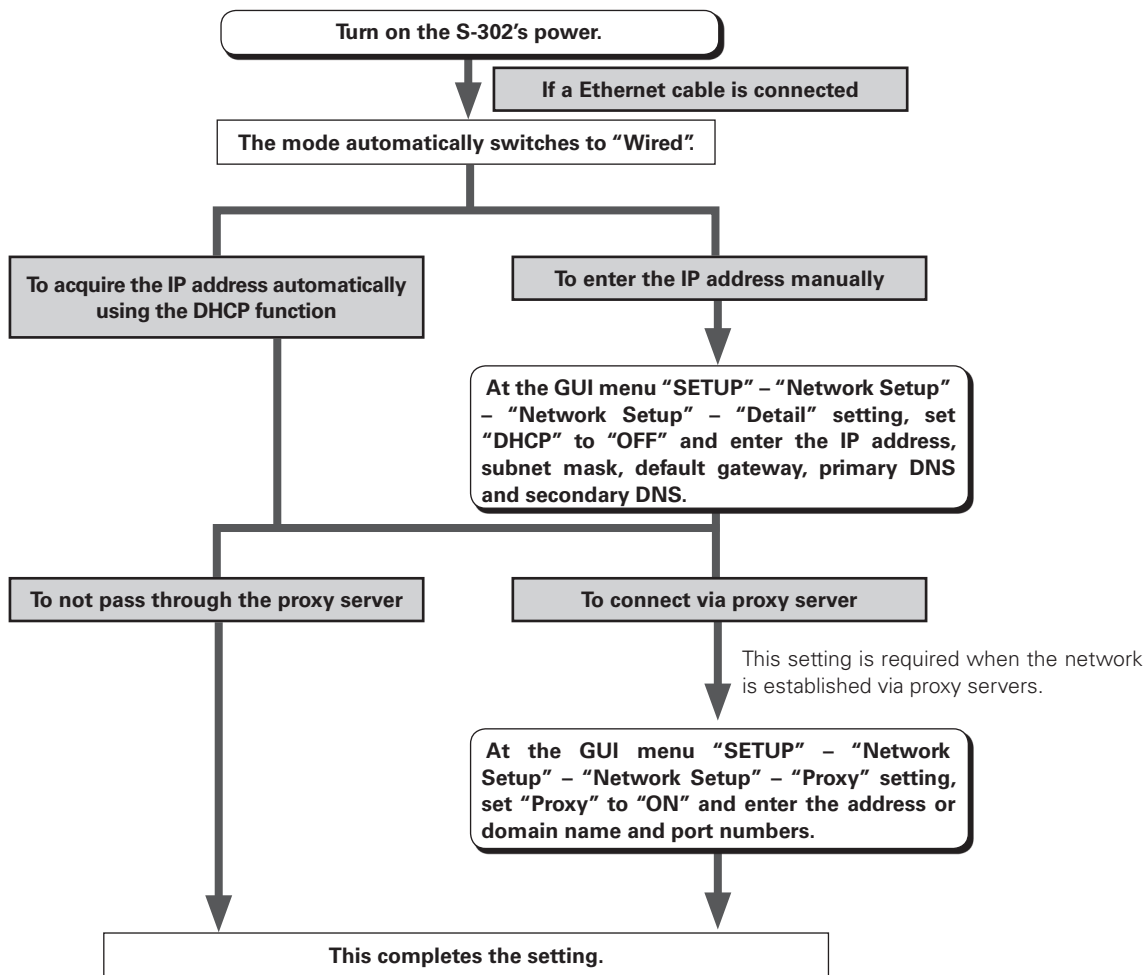

Recheck the connections and settings if you cannot connect to the Internet (🔗 page 15).

NOTE Knowledge about networks is required to make the IP address and proxy settings. For details, consult a network administrator.

Wireless LAN settings

Make settings for wireless LAN.

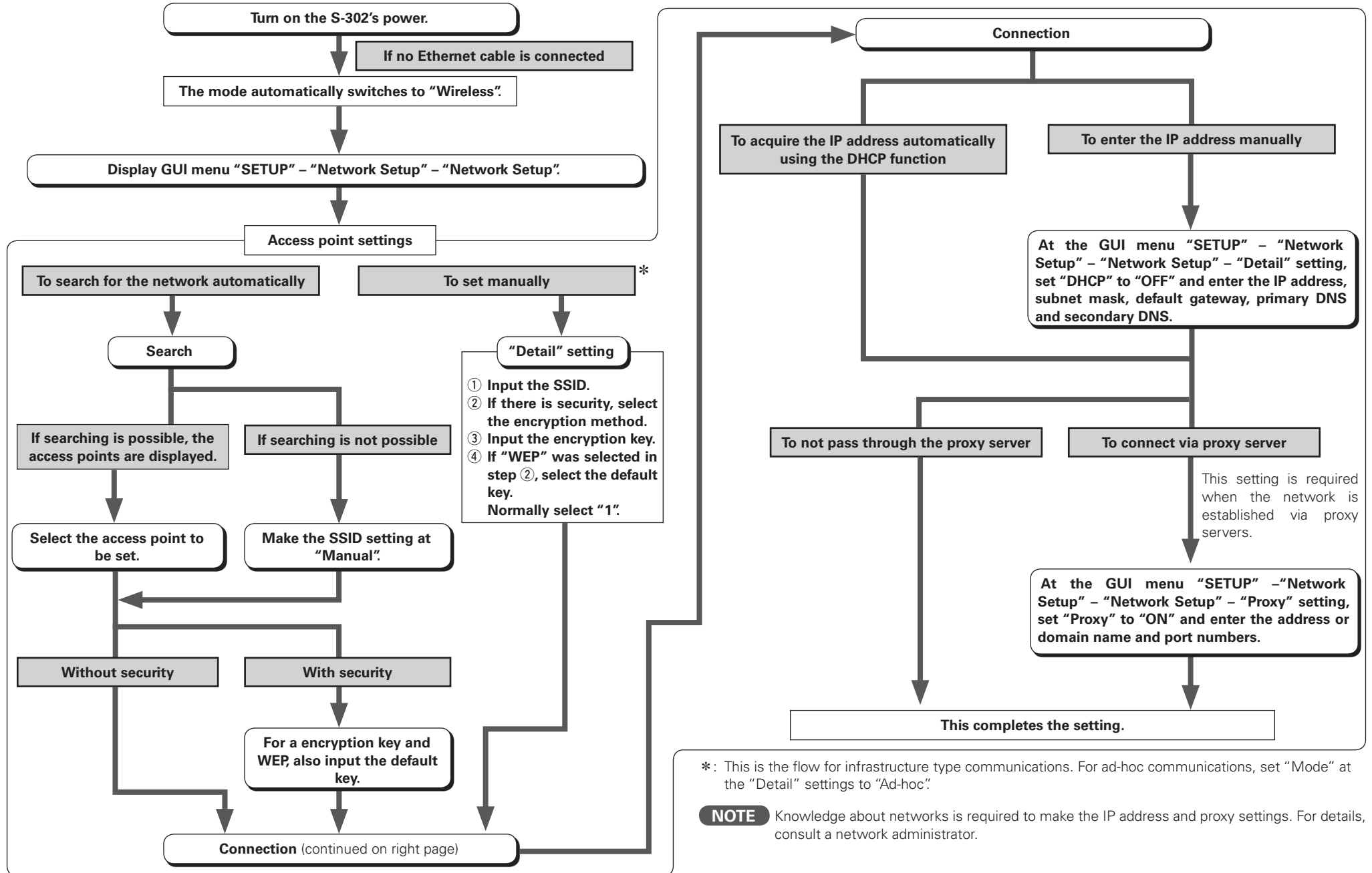

*: This is the flow for infrastructure type communications. For ad-hoc communications, set "Mode" at the "Detail" settings to "Ad-hoc".

NOTE Knowledge about networks is required to make the IP address and proxy settings. For details, consult a network administrator.

Other

Make setting for computer language environment.

Character

Set the character code type of the MP3 ID3-Tag played by USB.

[Selectable items] **Auto** **Latin** **Japanese**



If the characters are not properly displayed when set to "Auto", set to "Latin" or "Japanese".

PC Language

Select computer environment language.

[Selectable items] **ara** **chi (smp)** **chi (trad)** **cze** **dan**
dut **eng** **fin** **fre** **ger** **gre** **heb**
hun **ita** **jpn** **kor** **nor** **pol** **por**
por (BR) **rus** **spa** **swe** **tur**

Network Information

Display network information.

[Items to be checked] **Wired or Wireless** **SSID**
DHCP= ON or OFF **IP Address**
MAC Address

5 Others

Make various other settings.

Auto Power Mode

Control auto power-off 30 min. after DVD playback stop (power saver mode).

[Selectable items] **ON** **OFF**



This function only works when the input source is set to "DVD/CD".

Rating

Make viewer restriction related settings.

Rating Level

Select viewer restriction level.

[Selectable items] **0 (Lock All)** **1 ~ 7** **8 (No Limit)**



When "1 ~ 7" is selected, viewing cannot be restricted for adult DVDs on which no viewer restriction level has been recorded. However, when "0 (Lock All)" is selected, playback is prohibited for all discs, even discs on which no viewer restriction level has been recorded.

Password

Change password.

[Selectable items]

Old Password (0000 ~ 9999) **New Password (0000 ~ 9999)**
Confirm

Captions

Make settings for closed-caption info on DVD (separate decoder required).

[Selectable items] **ON** **OFF**



DVDs including closed caption signals are indicated by the and marks.

Subtitles are not displayed for DVDs not containing closed caption signals.

Display

Make display related settings.

On Screen Display

Make settings for display of operation information.

[Selectable items] **ON** **OFF**

Dimmer Sensor

Make settings for automatic display brightness adjustment.

[Selectable items] **ON** **OFF**

Display

Adjust display brightness of the receiver.

[Selectable items] **Bright** **Medium** **Dim** **OFF**

iPod Assign

Select iPod connection method.

[Selectable items]

iPod Connect Cable **DENON Dock** **Apple Dock**

Slide Show

Make slideshow settings.

[Selectable items] **5sec** ~ **15sec**

Custom Setting

Make settings for volume control.

[Selectable items] **Volume Limit Setting** **Startup Mode**

6 Timer

Settings for Timer.

Once Timer

Settings for once-only timer.

[Selectable items] **Enable** **Disable**

Start Time

Set Timer Start Time. (12-hour display)

Example: PM 0:35

End Time

Set Timer End Time. (12-hour display)

Example: PM 1:00

Function

Select Timer Function.

[Selectable items] **DVD/CD** **Tuner** **iPod**

Everyday Timer

Settings for Everyday Timer.

[Selectable items] **Enable** **Disable**

Start Time

Set Timer Start Time. (12-hour display)

Example: PM 0:35

End Time

Set Timer End Time. (12-hour display)

Example: PM 1:00

Function

Select Timer Function.

[Selectable items] **DVD/CD** **Tuner** **iPod**



- Be sure to set the current time if you want to use the timer playback function.
- When the function is set to "TUNER", also set the preset number.
- If the times set for the sleep timer, every timer and once timer overlap, the priority is as follows:
① sleep timer ② once timer ③ every timer

Checking whether or not the timer is enabled

In the standby mode, press the **STATUS** button.

The status is displayed on the S-302's display.

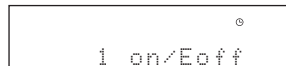

(When the once timer is on and the everyday timer is off)

Canceling the timer

Select "DISABLE".

To turn the timer back on, select "ENABLE".

Changing the timer settings

Redo the timer setting operation from the beginning.

The previous settings are cleared and replaced with the new settings.

If there has been a power failure

The settings are cleared.

Reset the current time, then make the settings over from the beginning.

Set Time

Set Current Time.



The clock is synchronized with the power supply frequency. It may be off by about 2 to 3 minutes per month.

In such cases, reset the time.

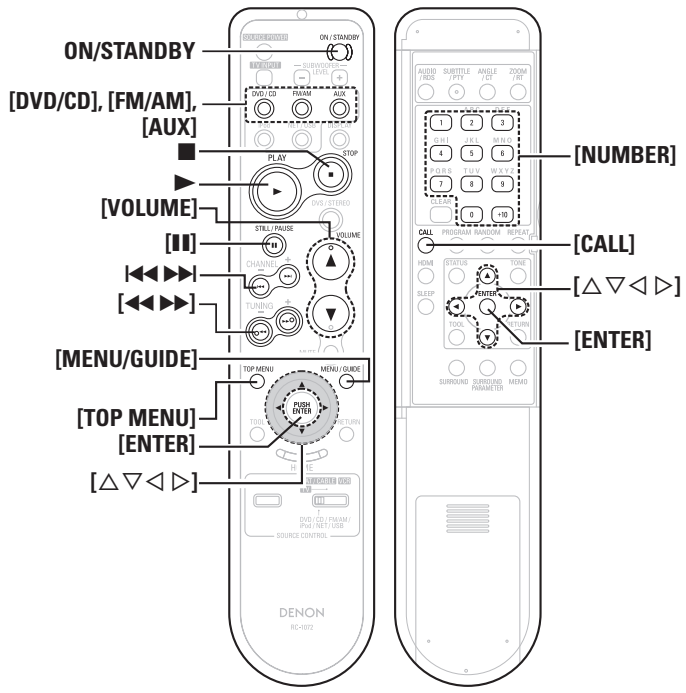
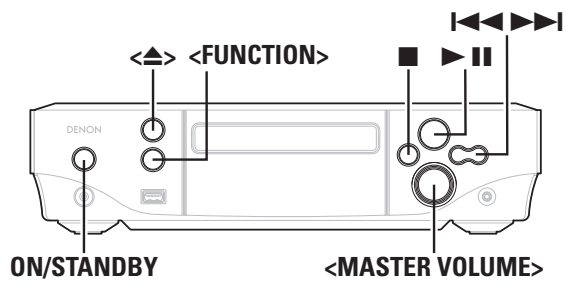

About the button names in these explanations
 < > : Buttons on the main unit
 [] : Buttons on the remote control unit
Button name only:
 Buttons on the main unit and remote control unit

Playback

Preparations

Turning the Power On

Press **ON/STANDBY**.
 When no disc is loaded, "0h00m00s" is displayed.
 When a disc is loaded, playback starts automatically. (DVD only)

Setting the power to the standby mode:

Press **ON/STANDBY**.

Turning the power off:

Unplug the power cord from the wall outlet.

Power indicator
StandbyRed **Power on**Blue
When the timer is setOrange

NOTE

Be sure to stop playback before turning the power off.

Loading Discs

In the stop mode, press **<▲>** to open the disc tray.
 ※ "Loading discs" (page 4).
 ※ As long as the menu is displayed on the TV screen, the disc is still turning. Be sure to stop the disc first, then open the disc tray.

To close the disc tray

Press **<▲>** again.

NOTE

Do not place any foreign objects in the disc tray. Doing so could damage it.

Input source switching

Press **<FUNCTION>** or **[DVD/CD]**, **[FM/AM]** or **[AUX]**.

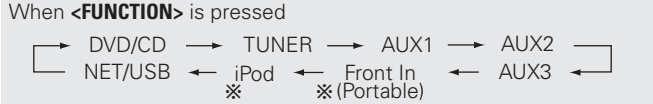

GUI : "DVD/CD"; "TUNER"; "AUX1" (page 17)

※ "iPod" and "Front In" are only displayed when the corresponding device is connected.
 ※ When using a Control Dock for iPod, "AUX2" is not displayed.

[Selectable items]

- DVD/CD** : You can view/listen to DVDs or CDs.
- TUNER** : You can listen to AM or FM broadcasts.
- AUX1, 2** : You can listen to the sound or view the picture of an external device.
- AUX3** : You can listen to the sound of an external device.
- FRONT IN** : You can listen to the sound of a portable player.
- iPod** : You can listen to the music of an iPod or view photo data.
- NET/USB** : You can listen to the Internet radio or music stored on a USB memory device.

Adjusting the Master Volume

Either turn **<MASTER VOLUME>** or press **[VOLUME ▲▼]**

The volume level is displayed.
 ※ The volume can be adjusted within the range of -60 to 0 to +18dB. Depending on the input signal, surround mode, speaker settings and channel level settings, however, it may not be possible to adjust the volume up to +18dB.

Playing a DVD/Music CD Disc

Press ►.
The "►" indicator lights and playback begins.



- For details, refer to the respective disc's instructions. Some discs may be intentionally designed by their authors to work in ways other than described in this manual.
- Before playing DVD video discs, switch the connected TV's input.

Stopping playback

Press ■.



- **Resume play memory function (DVD only)**
With the S-302, when the ■ button is pressed, that position is stored in the memory. (At this time, "►" flashes on the display.)
When the ► button is pressed after pressing the ■ button, playback resumes from the position at which it was stopped.
- ※ The resume play memory function is canceled if the disc tray is opened or the ■ button is pressed a second time.
- ※ The resume play memory function only works for discs for which the elapsed time is shown on the display during playback.

Stopping playback temporarily

Press <▶||> or [||].
The "||" indicator lights.
※ To resume playback, press <▶||> or [▶].

Fast-forwarding and fast-reversing (searching)

During playback, press [◀◀] or [▶▶].
The fast-forward/fast-reverse speed increases each time the button is pressed.
※ To return to normal playback, press [▶].

Moving to the beginning of tracks (skipping)

Press ►► or ◀◀ during playback.

- The disc is skipped the number of chapters or tracks equal to the number of times the button is pressed.
- When pressed once in the return direction, playback returns to the beginning of the currently playing chapter or track.
- If pressed within 3 seconds after playback has started, the previous chapter is selected.

Finding tracks directly

- 1 During playback, use [CALL] to select the search mode.**
For DVD video discs: Title ↔ Chapter
- 2 Press [NUMBER] (0 ~ 9, +10) to select the track.**
Example : Track 4 : [4]
Example : Track 12 : [+10] [2]
Example : Track 20 : [+10] [+10] [0]
※ The search mode set by pressing [CALL] is stored in the memory until the power is turned off.



Discs are divided into a number of large sections (Title) and small sections (Chapter). Each of these sections is assigned a number.

For example:
DVD Video

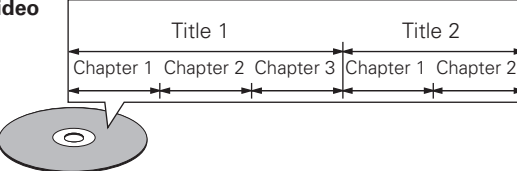

Music CDs

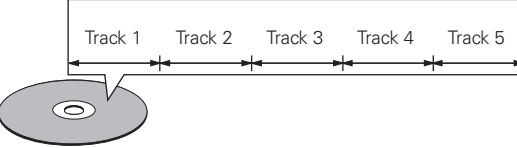

Using the Top Menu/DVD Menu (DVD Video)

On DVDs containing multiple titles, it is possible to select and play the desired title from the top menu. Some DVDs include a special menu called the "DVD menu".

1 During playback, use [TOP MENU] or [MENU/GUIDE].

2 Use [△▽◀▶] to select the desired title, then press [ENTER] or ►.
Or, use [NUMBER] (0 ~ 9, +10) to select the desired title.
Playback starts.

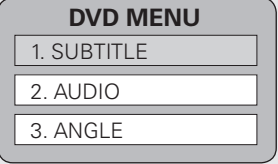
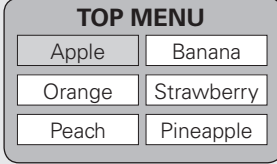

Example : Top menu

Example : DVD menu

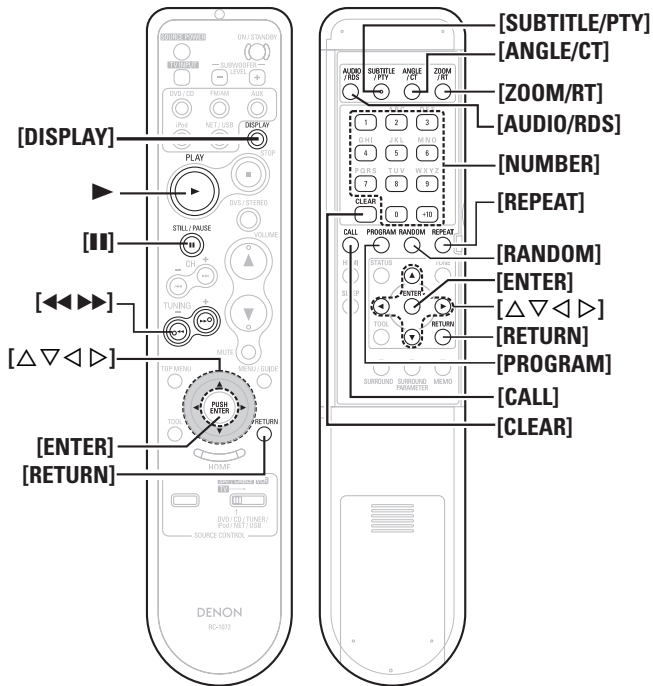
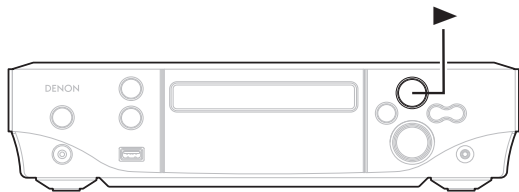

About the button names in these explanations

< > : Buttons on the main unit
 [] : Buttons on the remote control unit

Button name only:

Buttons on the main unit and remote control unit

Switching the Audio Language, Subtitle Language and Angle (DVD Video)

For DVDs containing multiple audio languages, subtitle languages and angles, the language or angle can be switched during playback.

During playback, use [AUDIO/RDS], [SUBTITLE/PTY] or [ANGLE/CT].

The language or angle switches each time the button is pressed.



- With some discs it is not possible to change the audio language during playback. In such cases, select from the "GUI SETUP".
- The language selected in the default settings (page 18) is set when the power is turned on and when the disc is replaced.

Using the Playback Control Function (DVD Video)

For DVD Video on which "Includes playback control" or the like is indicated on the disc or jacket, a menu screen is displayed.

Select the item you want to see, then start playback.

Select the item you want to see using [Δ▽◁▷], then press [ENTER] or ►.

Or, use [NUMBER] (0 ~ 9, +10) to select the desired title. Playback starts.

Example :

1. Opening
2. 1st movement
3. 2nd movement
4. 3rd movement
5. Ending

To return to the menu screen

During playback, press [RETURN].

Playing Frame by Frame (DVD Video)

In the still mode, press [II] on the remote control unit.

The picture moves forward one frame each time the button is pressed.

※ Press ► to return to normal playback.

Slow Playback (DVD Video)

In the still mode, press [◀◀] or [▶▶] on the remote control unit.

When pressed again, the slow play speed increases.

※ Press ► to return to normal playback.

Playing in the Zoom Mode (DVD Video)

1 During playback or still mode, press [ZOOM/RT].

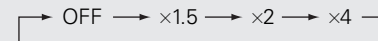

2 Press [Δ▽◁▷].

Move the zoomed picture.



- The zoom function may not work properly at some scenes.
- Zooming is not possible with some discs.
- Zooming is not possible at the top menu or the menu screen.

Playing Repeatedly <Repeat playback> (DVD Video/Music CD)

During playback, press [REPEAT].

Playback in the respective repeat mode starts.

※ DVD video discs:

- Chapter repeated ("1" lights on the display)
- Title repeated ("1" lights on the display)
- Repeat playback cancelled (indicator turns off) →

※ Music CD discs:

- Track repeated (1)
- Disc repeated (1) → Repeat playback cancelled →

Playing Tracks in the Desired Order <Program> (Music CD)

Up to 20 tracks can be programmed.

1 In the stop mode, press [PROGRAM].

The "PROG" indicator lights.

2 Use [NUMBER] (0 ~ 9, +10) to select the tracks.

- ※ **Example** : To program tracks 3, 12, 7 to play in that order:
[3] [+10] [2] [7]

3 Press ▶.

Checking the order of the programmed tracks

In the stop mode, press [CALL] repeatedly.

The track numbers are displayed in the programmed order each time the button is pressed.

Clearing programmed tracks one track at a time

In the stop mode, press [CLEAR].

The last track programmed is cleared each time the button is pressed.

Clearing the last programmed track

In the stop mode, press [PROGRAM].

The "PROG" indicator turns off.

Playing Random Order <Random playback> (Music CD)

1 In the stop mode, press [RANDOM].

The "RAND" indicator lights.

2 Press ▶.

The tracks start playing in random order.

Canceling random playback

In the stop mode, press [RANDOM].

The "RAND" indicator turns off.

Playing Music Files

Before Playing MP3 or WMA Files

There are many music distribution sites on the Internet allowing you to download music files in MP3 or WMA (Windows Media® Audio) format. The music (files) downloaded from such sites can be stored on CD-R or CD-RW discs and played on the S-302.

"Windows Media" and "Windows" are registered trademarks or trademarks in the United States and other countries of Microsoft Corporation of the United States.

Creating MP3 and WMA Files Compatible with the S-302

- Writing software format: "ISO9660 level 1"
See the writing software's instructions.
- Compatible: ID3-Tag (Ver.1 or 2), meta-tag.
- Incompatible: Packet write, playlists.
- Displayable characters: "Hankaku" English letters and numbers, capital letters and _ (underscore).
No. characters displayable: 256

- When Playing MP3 or WMA Files, the digital output is converted to PCM. The signals are output with the same sampling frequency as when they were written.
- The positions of the folders or files may have been changed by the writing software when burning the MP3/WMA files onto the CD-R/CD-RW disc, so the files may not play in the expected order.
- Copyright-protected files cannot be played. Note that depending on the software used for burning and other conditions, some files may not play or display correctly.

Playable MP3/WMA file			
File format	Sampling frequency (kHz)	Bit rate (kbps)	Extension
MP3	32, 44.1, 48	32 ~ 320	.MP3
WMA	32, 44.1, 48	64 ~ 160	.WMA

Playing MP3 or WMA Files

1 Load a CD-R or CD-RW disc containing music files in the MP3 or WMA format into the disc tray (▶ page 4).

2 Select the folder you want to play using [Δ ∇], then press [ENTER].

3 Select the file you want to play using [Δ ∇], then press [ENTER] or ▶. Playback starts.

Switching the time display

During playback, press [DISPLAY].

※ SINGLE ELAPSED (Elapsed time of currently playing track)

→ SINGLE REMAIN (Remaining time of currently playing track) →

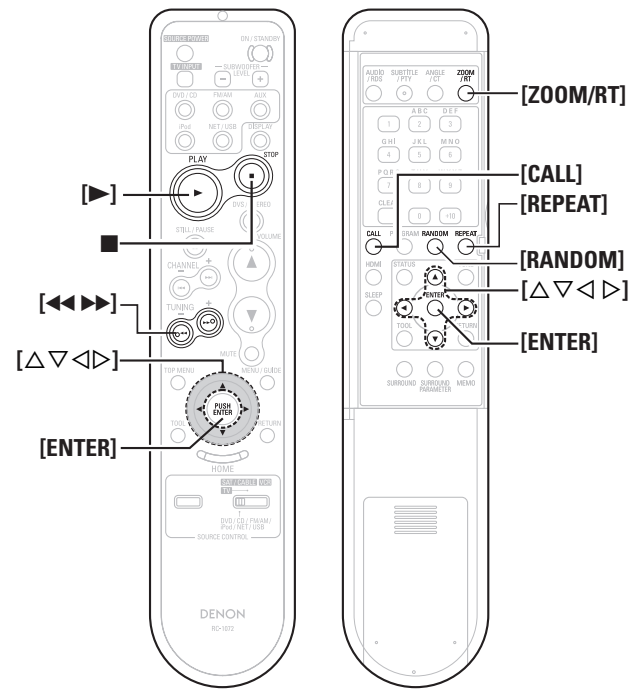
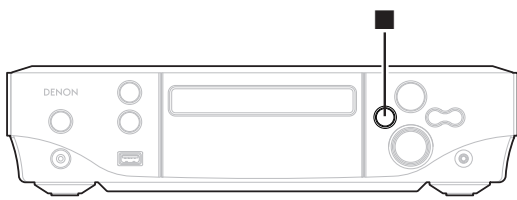

About the button names in these explanations
 < > : Buttons on the main unit
 [] : Buttons on the remote control unit
Button name only:
 Buttons on the main unit and remote control unit

Changing the play mode

FOLDER:

Playing all the files in the selected folder in order

FOLDER REPEAT:

Playing all the files in the selected folder repeatedly

RANDOM ON:

Playing all the files in the selected folder in random order

TRACK REPEAT:

Playing only the selected file repeatedly

Setting random playback using the remote control unit

In the stop mode, press [RANDOM], then press [▶] or [ENTER]. The "RAND" indicator lights and random playback begins.

※ The way in which the files are played in random order depends on the selected play mode.

Setting repeat playback using the remote control unit

During playback, press [REPEAT], then press [▶] or [ENTER].

※ TRACK REPEAT → FOLDER REPEAT → FOLDER (Repeat off)



Programmed playback is not possible on discs containing MP3/WMA files.

Playing Still Picture Files (JPEG format)
 Still picture files in JPEG format recorded on CD-R/CD-RW discs, picture CDs and Fujicolor CDs can be played as slide shows on the S-302.

Creating JPEG Files Compatible on the S-302

- Writing software format: "ISO9660 level 1". See the writing software's instructions.
- Displayable characters: "Hankaku" English letters and numbers, capital letters and _ (underscore).
- JPEG files written on Macintosh computers cannot be played.
- The order in which the JPEG files are played may differ from the order you expect because the writing software may change the position of the folders or files when writing them on the CD-R/CD-RW disc.
- Depending on the writing conditions and software, it may not be possible to play or display properly some files.

Playable JPEG file	
Resolution (pixel)	Extension
0000×0000 ~ 2048×1536	.JPG/.JPE

Playing JPEG Files

Operate in the same way as described at “Playing MP3 or WMA Files” (🔧 page 27).

Changing the folder or file to be played

“Playing MP3 or WMA Files” (🔧 page 27)

Changing the play mode

“Playing MP3 or WMA Files” (🔧 page 28)

Changing the orientation of the picture

During playback or still mode, press [△▽◁▷].

△: Invert vertically

▽: Invert horizontally

◁: Rotate 90° counterclockwise

▷: Rotate 90° clockwise

Play the image in the zoom mode

During playback or still mode, press [ZOOM/RT].

◀◀: zoom out

▶▶: zoom in

※ Press [△▽◁▷] (to move the zoomed picture).

※ Continuous playback (SLIDE SHOW) is not possible in the zoom mode.

The way of switching to the next image during continuous JPEG image playback (SLIDE SHOW) can be selected

During playback, press [CALL].

SLIDE SHOW MODE: 1 to 11 → RANDOM → OFF

Playing Picture CD/Fujicolor CD

The S-302 can play Kodak Picture CDs and Fujifilm Fujicolor CDs so you can view the photographs stored on them on a TV screen.

※ Picture CDs are CDs containing photographs taken on conventional silver film cameras which have been converted into digital data. For details on Kodak Picture CDs and Fujicolor CDs, please contact a store offering film development services.

“KODAK” is a trademark of Eastman Kodak Company.
“FUJICOLOR CD” is a trademark of Fuji Photo Film Co, Ltd.

Load the picture CD or Fujicolor CD in the disc tray.

Playback of the still pictures starts automatically.

※ The pictures are played repeatedly until ■ is pressed.

Enjoying Surround Sound

Dolby Digital, DTS and other multi-channel sources, CD, video and other 2-channel sources can be played with similar atmospherics to the cinema.

[Connection procedure]

- ① Turn on the power of the S-302 and TV.
 (“Turning the Power On” (🔧 page 24), TV operating instructions)
- ② Switch the TV’s input.
 (TV operating instructions)
- ③ Switch the input source (🔧 page 24).
- ④ Set the input mode.
- ⑤ Select the surround mode.
- ⑥ Play the source.
- ⑦ Set the surround parameter (🔧 page 30).
- ⑧ Adjust the volume (🔧 page 24).

Set the Input Mode

When the input source is set to “DVD/CD,” “AUX1” or “AUX2,” the input mode can be switched (“Audio setup,” “Input mode” (🔧 page 19).



- When playing CDs containing live recordings, etc., in the “auto” mode, the sound may be slightly broken when starting playback. If so, play in the “PCM” mode.
- When playing DTS sources in the “AUTO” mode, there may be noise when starting playback or searching. If so, play in the “DTS” mode.
- When playing DTS-compatible CDs in the “PCM” mode, noise is output. When playing DTS-compatible sources, be sure to do so in the “auto” or “DTS” mode.

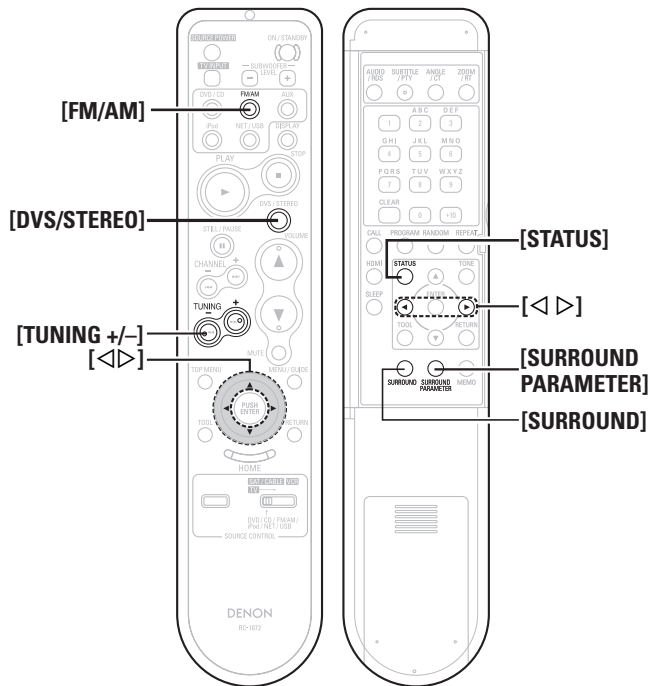
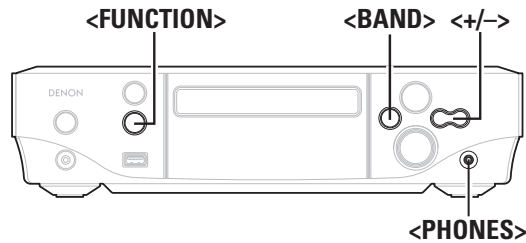

Selecting Surround Mode

Press **[SURROUND]** to select the surround mode.

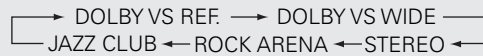

※ The “DOLBY VS REF. (WIDE)” and “STEREO” modes can also be selected by pressing **[DVS/STEREO]**.

[Selectable items]

DOLBY VS REF.

(Dolby Virtual Speaker reference mode):

This is the standard mode for experiencing 5.1-channel surround sound with only speakers for the two front channels.

DOLBY VS WIDE

(Dolby Virtual Speaker wide mode):

The Dolby Virtual Speaker mode's front channel sound field is expanded.

DOLBY H/P (Dolby Headphone mode):

This is the surround mode for playing with headphones. A surround sound field is played with regular headphones.

DOLBY H BYPASS (Dolby Headphone bypass mode):

The sound is played in the normal stereo mode rather than the surround mode when playing with headphones.

STEREO :

Sound is played in the direct or stereo mode.

ROCK ARENA :

This is an original DENON surround mode. It achieves the atmosphere of a live concert in an arena with reverberations circling in from the sides.

JAZZ CLUB :

This is an original DENON surround mode. This achieves the atmosphere of a live concert hall with a low ceiling surrounded by hard walls, as if the artist were playing very close to you.



The “ROCK ARENA” and “JAZZ CLUB” modes may not achieve very strong effects, depending on the source being played. In this case, try other surround modes, without worrying too much about their names.

Set the Surround Parameter

Use **[SURROUND PARAMETER]** to display the various surround parameters, then select with **[<>]**.

After several seconds, the display returns to normal and the parameters you have set are entered automatically.

[Selectable items]

D.COMP (Dynamic range compression):

Optimized setting for late-night listening. D.COMP only works when playing program sources record in Dolby Digital or DTS.

LFE (Low Frequency Effect):

This sets the level of the subwoofer reproducing the low bass signals.

※ Recommended level

- When playing Dolby Digital software: 0 dB
- When playing DTS movie software: 0 dB
- When playing DTS music software: -10 dB

CINEMA :

When the Dolby Headphone mode is selected, analog, PCM or other 2-channel sources are decoded in the Dolby Pro Logic II Cinema mode and transformed into multiple channels for playback.

MUSIC :

When the Dolby Headphone mode is selected, analog, PCM or other 2-channel sources are decoded in the Dolby Pro Logic II Music mode and transformed into multiple channels for playback.



About the button names in these explanations

- < > : Buttons on the main unit
- [] : Buttons on the remote control unit

Button name only:

Buttons on the main unit and remote control unit

Playing Dolby Digital/DTS Multi-Channel Sources (Digital input only)

- 1 Switch the input source (👉 page 24).
(DVD, AUX1 or AUX2 digital input)
- 2 Use [SURROUND] to select the "DOLBY VS REF" or "DOLBY VS WIDE".
The "□□ VS" indicator lights.
- 3 Play sources with the  or  mark sources.
The "□□□" or "□□□" indicator lights, depending on the playback source's signal format.
- 4 Use [SURROUND PARAMETER] to display the various surround parameters, then select with [◀ ▶].

[Selectable items] **D.COMP** **LFE**

Playing Dolby Digital/PCM/Analog 2-Channel Sources

- 1 Switch the input source (👉 page 24).
- 2 Use [SURROUND] to select the "DOLBY VS REF" or "DOLBY VS WIDE".
The "□□ VS" indicator lights.
- 3 Play sources with the  mark or PCM/Analog sources.
The "□□□" indicator lights, depending on the playback source's signal format.
- 4 Use [SURROUND PARAMETER] to display the various surround parameters, then select with [◀ ▶].

[Selectable items] **D.COMP** **LFE**

To check the currently playing source and various settings

In the stop mode, press [STATUS].

※ The playback source and the various surround settings are shown on the display each time the button is pressed.

Listening in the Dolby Headphone Mode

- 1 Switch the input source (👉 page 24).
Plug the headphones (sold separately) into the <PHONES> jack.
The sound from the speakers is automatically cut off.
- 2 Press [SURROUND] to select the "DOLBY H/P".
The "□□H" indicator lights.
- 3 Play the source.
- 4 Use [SURROUND PARAMETER] to display the various surround parameters, then select with [◀ ▶].

[Selectable items]



D.COMP **LFE** **CINEMA** **MUSIC**

NOTE

Be careful not to set the volume too high when using headphones.

Listening to Radio Broadcasts

Tuning in Broadcast Stations

- 1 Use <FUNCTION> or [FM/AM] to select "TUNER".

- 2 Use <BAND> or [FM/AM] to select the reception band.

- 3 Use <+/->, [TUNING +/-] or [◀ ▶] to select the reception frequency.
When a station is received, the "TUNED" indication will light.



A humming sound may be heard when using a TV nearby while receiving AM programs. If this happens, move the system as far from the TV as possible.

Display of the FM broadcast reception status

- When the reception band mode is set to "FM AUTO" and a stereo broadcast is tuned in, the "ST" indicator lights.
- If the signal is weak and stable stereo reception is not possible, set the reception band mode to "FM MONO" and receive the program in monaural. The "MONO" indicator lights.

Main unit <+/-> button

There are two, switchable modes for <+/-> the tuning mode for setting the reception frequency (setting upon purchase), and the preset mode for selecting the preset broadcast station.

☐ Switching the preset mode

Pressing <+> while pressing in <BAND>.

"PRESET" is flashes for approximately 5 seconds.

☐ Switching the tuning mode

Pressing <-> while pressing in <BAND>.

"TUNING" is flashes for approximately 5 seconds.

Auto tuning

When <+/->, [TUNING +/-] or [◀ ▶] is pressed and held in, the set automatically starts searching for a broadcast station.

※ Stations whose signal is weak cannot be tuned in.

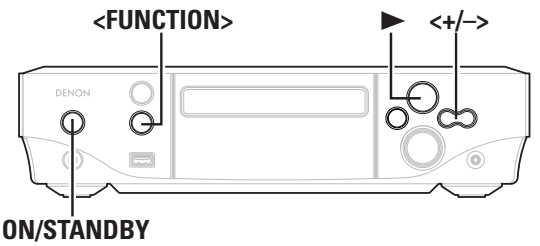

ON/STANDBY

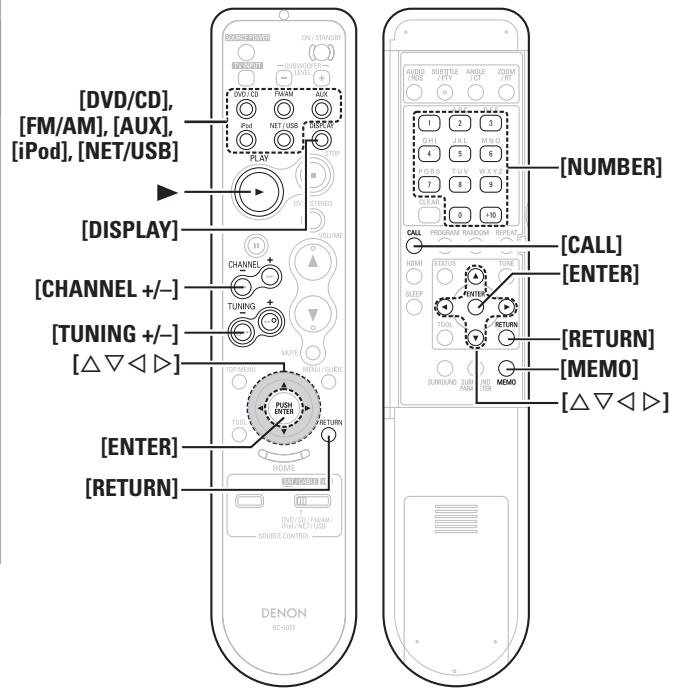

About the button names in these explanations
 < > : Buttons on the main unit
 [] : Buttons on the remote control unit
Button name only:
 Buttons on the main unit and remote control unit

To stop the auto tuning

Press <+/->, [TUNING +/-] or [◀ ▶].

Manual tuning

The reception frequency changes each time <+/->, [TUNING +/-] or [◀ ▶] is pressed.

Naming the Currently Tuned in Broadcast Station and Presetting it
 Up to 60 stations (total for AM and FM) can be preset.
 Names of up to 8 characters can be input.

- 1 Tune in the broadcast station**
- 2 Press [MEMO] twice.**
The name input mode is set.
- 3 Use [Δ ▽] to select the character , then press [ENTER].**
* Characters that can be input.

A to Z, 0 to 9 + [CALL] for small letters
 ! " # \$ % & ' () * + , - . / : ; < = > ? @ [\] ^ _ { | } (space)

 * Press [◀ ▶] to move the cursor.
 Use this to correct input characters.
 * To cancel character input, press [MEMO].
 Everything that has been input is canceled.
- 4 Once you are finished inputting, press [ENTER].**
"P0 -" flashes on the preset number display.
- 5 Use [Δ ▽] to select the number, then press [ENTER].**
 Or use [NUMBER] (0 ~ 9, +10) to select the number.
 The preset number, reception band and reception frequency are displayed, then the name of the broadcast station appears.

Changing the broadcast station name

- ① Call out the preset name you want to change, then press [MEMO] twice.
- ② Perform steps 3 and 4 at "Naming the currently tuned in broadcast station and presetting it"

To only preset

- ① Press [MEMO] while the broadcast station is tuned in.
- ② Select the number using [Δ ▽], then press [ENTER].
 Or use [NUMBER] (0 ~ 9, +10) to select the number.

NOTE

If a station is preset at a number that has already been preset, the old settings are deleted and replaced with the new settings.

Automatically Presetting FM Stations (Auto preset)

Up to 60 stations can be preset.

- 1 Use <FUNCTION> or [FM/AM] to select "TUNER".**

GUI : "TUNER" (☞ page 17)
- 2 Press and hold in <▶>.**
 "AUTO PRESET?" and "-:NO/+START" are displayed alternately.
 * Press <-> to cancel auto presetting.
- 3 Press <+>.**
 "SEARCH" flashes, then "COMPLETED" is displayed.



- Broadcast stations whose antenna signal are weak cannot be preset automatically. If you wish to preset such stations, tune them in manually.
- Once auto presetting starts, it cannot be canceled (it takes about 60 seconds to be completed).

Listening to Preset Stations

Use <+/->, [CHANNEL] or [NUMBER] (0 ~ 9, +10) to select the preset number.

* Operate <+/-> after switching to the preset mode (☞ page 315).

iPod® Playback

With the S-302, you can listen to music or view photo data on an iPod. It is also possible to operate the iPod from the main unit or remote control unit.



iPod is a trademark of Apple Computer, Inc., registered in the U.S. and other countries.

※ The iPod may only be used to copy or play contents that are not copyrighted or contents for which copying or playback is legally permitted for your private use as an individual. Be sure to comply with applicable copyright legislation.

NOTE

- DENON will accept no responsibility whatsoever for any loss of iPod data.
- Depending on the type of iPod and the software version, some functions may not operate.

Listening to Music

1 Use <FUNCTION> or [iPod] to select “iPod”.

GUI : “iPod” (☞ page 17)

2 Turn on the TV’s power. Set the TV’s input function to the S-302 input.

3 Press [ENTER] or ►.

Playback starts.

※ Also read the iPod’s operating instructions.

Switching the S-302’s display (FL)

During playback, press [DISPLAY].
The display switches each time the button is pressed.



- In the browse mode, when “Songs” is selected from the “TOP MENU” while a track is playing, the track stops.
- The maximum battery charging output from the iPod terminal is 8W.
- See page 33 for the remote control unit buttons that can be operated when the function is set to “iPod”.

Viewing Still Pictures (Only for iPods Equipped with the Photo Function)

1 Use <FUNCTION> or [iPod] to select “iPod”.

GUI : “iPod” (☞ page 17)

2 Turn on the TV’s power. Set the TV’s input function to the S-302 input.

3 Press [RETURN] to select the “Remote iPod”.
The iPod’s display menu is displayed.

4 Watching the iPod’s display, press [△▽] to select the “Photos”.

5 Press [ENTER].
The iPod’s photographs are displayed on the TV monitor.



When an iPod is connected and a slide show is playing, the iPod is not charged. Charge it ahead of time.

Disconnecting the iPod

Set the S-302’s power to the standby mode using **ON/STANDBY**.



It is also possible to use <FUNCTION>, [DVD/CD], [FM/AM], [AUX] or [NET/USB] to switch the input source to something other than “iPod” then disconnect the iPod.

Remote control and iPod button relations

Remote control unit buttons	iPod buttons	Operation on the S-302
►	▶▶	Play the track. ※ Play/Pause in remote mode
⏸	▶▶	Pause the track.
◀◀ ▶▶	◀◀ ▶▶	Play the track from the beginning/ Play the next track.
◀◀ ▶▶	◀◀ ▶▶	Fast-reverse the track/Fast-forward the track.
◀, ▶, △, ▽	Click Wheel	Select an item.
ENTER	Select	Enter the selection or plays the track.
RETURN	-	Switch between the browse mode and the remote mode.
REPEAT	-	Switch the repeat function.
RANDOM	-	Switch the shuffle function.
MENU/GUIDE	MENU	Display the menu or return to the previous menu. ※ In remote mode, the iPod backlight goes off when you press Play/Pause for an extended period.

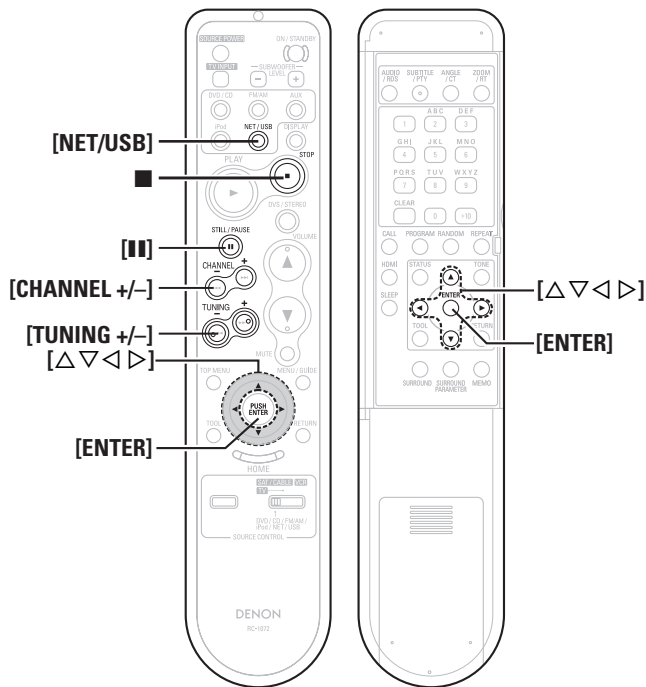
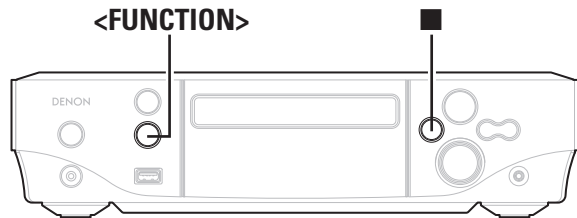

About the button names in these explanations
 < > : Buttons on the main unit
 [] : Buttons on the remote control unit
Button name only:
 Buttons on the main unit and remote control unit

Playing Network Audio or USB Memory Devices

This procedure can be used to play Internet radio stations or music or still picture (JPEG) files stored on a computer or USB memory device.

❑ About the Internet radio function

- Internet radio refers to radio broadcasts distributed over the Internet. Internet radio stations from around the world can be tuned in. The S-302 is equipped with the following Internet radio functions:
 - Stations can be selected by genre and region.
 - Internet radio stations in MP3 and WMA (Windows Media Audio) format can be listened to.
 - Your favorite radio stations can be registered by accessing an exclusive DENON Internet radio URL from a Web browser on a computer.
 - The function is managed for individual users, so you must provide your MAC or e-mail address.
 - Exclusive URL: <http://www.radiodenon.com>
 - The radio station database service may be suspended without notice.
- The S-302's Internet radio station list is created using a radio station database service (vTuner). This database service provides a list edited and created for the S-302. vTuner services may be discontinued without notice.

❑ Music server

- This function lets you play music files and playlists (m3u, wpl) stored on a computer (music server) connected to the S-302 via a network. With the S-302's network audio playback function, connection to the server is possible using one of the technologies below.
 - Windows Media Player Network Sharing Service
 - Windows Media DRM10

[Album art function]

When a WMA (Windows Media Audio), MP3 or MPEG-4 AAC file includes album art data, the album art can be displayed while the music files are playing.



For music files in WMA (Windows Media Audio) format, the album art is only played when using Windows Media Player ver. 11.

[Slide show function]

Still picture (JPEG) files stored in folders on a music server can be played as slide shows. The time for which each picture is displayed can be set.



When still picture (JPEG) files are played on the S-302, they are played in the direction in which they are stored in the folder, so store in them in the direction in which you want them to play.

Installing Windows Media Player ver. 11

- If Windows XP Service Pack 2 has not yet been installed, either download it free of charge from Microsoft or install it via a Windows update installer.
 - Download the latest version of Windows Media Player ver. 11, either directly from Microsoft or using a Windows update installer.
- ※ When using Windows Vista, there is no need to download a new version of Windows Media Player.

❑ USB memory devices

- A USB memory device can be connected to the S-302's USB port to play music and still picture (JPEG) files stored on the USB memory device.
 - Only USB memory devices conforming to mass storage class and MTP (Media Transfer Protocol) standards can be played on the S-302.
 - The S-302 is compatible with USB memory devices in "FAT16" or "FAT32" format.

[Album art function]

When an MP3 music file includes album art data, the album art can be displayed while playing the file.

[Slide show function]

Still picture (JPEG) files stored on USB memory devices can be played as slide shows. The time for which each picture is displayed can be set.



When still picture (JPEG) files are played on the S-302, they are played in the direction in which they are stored in the folder, so store in them in the direction in which you want them to play.

[Compatible formats]

	Internet radio	Music server*	USB*
WMA (Windows Media Audio)	○	○	○*
MP3 (MPEG-1 Audio Layer-3)	○	○	○
WAV *	–	○	○
MPEG-4 AAC	–	○*	○*
FLAC (Free Lossless Audio Codec)	–	○	○
JPEG	–	○	○

*: Only files that are not protected by copyright can be played on the S-302.

※ Contents downloaded from pay sites on the Internet are copyright protected. Also, files encoded in WMA format when ripped from a CD, etc., on a computer may be copyright protected, depending on the computer's settings.

- The S-302 is compatible with MP3 ID3-Tag (Ver. 2) standards.
- The S-302 is compatible with WMA META tags.

[Playable formats]

	Sampling frequency	Bit rate	Extension
WMA (Windows Media Audio)	32/44.1/48 kHz	48~192 kbps	.wma
MP3 (MPEG-1 Audio Layer-3)	32/44.1/48 kHz	32~320 kbps	.mp3
WAV	32/44.1/48 kHz	–	.wav
MPEG-4 AAC	32/44.1/48 kHz	16~320 kbps	.aac/.m4a/.mp4
FLAC (Free Lossless Audio Codec)	32/44.1/48 kHz	–	.flac

WAV format Quantization bit rate: 16 bits.

Basic Operation

1 Make the necessary preparations.

- ① Check the network environment, then turn on the S-302's power. (☞ page 15 "Network Audio")
- ② If settings are required, make the network settings. (☞ page 20 ~ 22 "Network Setup")
- ③ Prepare the computer. (☞ Computer's operating instructions) Install "Windows Media Player ver. 11".

2 Use <FUNCTION> or [NET/USB] to select "NET/USB".

 GUI: "NET/USB" (☞ page 17)

3 Use [△▽] to select the menu, then press [ENTER] or [▷] to select the file you want to play.

4 Press [ENTER] or [▷].
Playback starts.

Stopping playback temporarily

During playback, press [II].

To stop

During the play or pause mode, press ■.

Searching up or down pages

Press [CHANNEL -] (down) or [CHANNEL +] (up).

Searching by first letter (Character search)

This operation is convenient for choosing items from the menu screens for Internet radio stations or files stored on the computer.



- The time for which the GUI menus are displayed can be set at GUI menu "NET/USB" (☞ page 17).
- The display can be switched between the artist name, track name, album name.

Listening to Internet Radio

1 Use [△▽] to select "Internet Radio", then press [ENTER] or [▷].

2 Use [△▽] to select the item you want to play, then press [ENTER] or [▷].

The station list is displayed.

A "II" mark is indicated in front of stations that can be played.

3 Use [△▽] to select the station, then press [ENTER] or [▷].

Playback starts once buffering reaches "100%".



- There are many Internet radio stations on the Internet, and the quality of the programs they broadcast as well as the bit rate of the tracks varies widely.

Generally, the higher the bit rate, the higher the sound quality, but depending on the communication lines and server traffic, the music or audio signals being streamed may be interrupted.

Inversely, lower bit rates mean a lower sound quality but less tendency for the sound to be interrupted.

- "Server Full" or "Connection Down" is displayed if the station is busy or not broadcasting.
- On the S-302, folder and file names can be displayed as titles. Any characters that cannot be displayed are replaced with " ." (period)." . (period)"

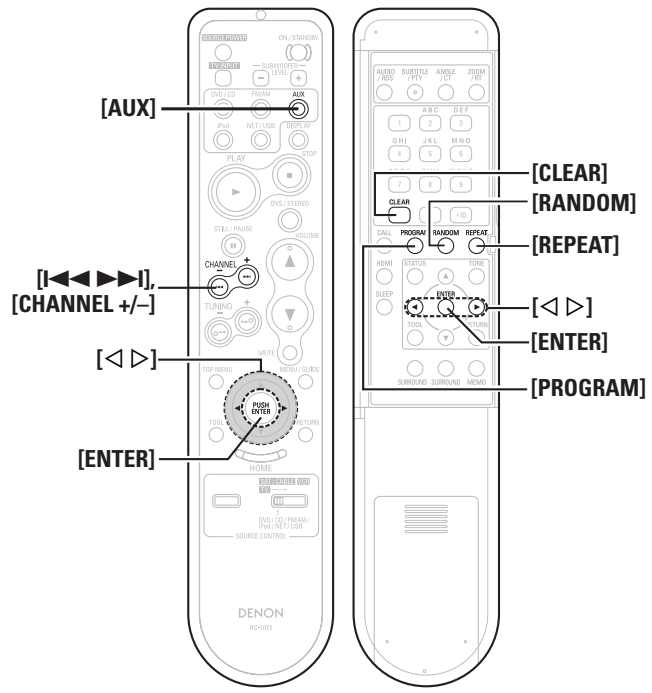
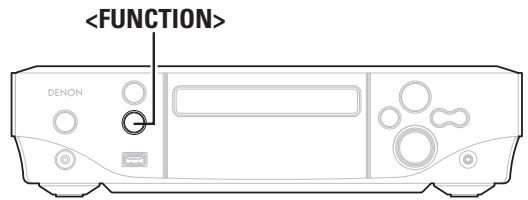

About the button names in these explanations
 < > : Buttons on the main unit
 [] : Buttons on the remote control unit
Button name only:
 Buttons on the main unit and remote control unit

Recently Played Internet Radio Stations

Recently played internet radio stations can be selected from “Recently Played” in top menu.

- 1** Use [$\Delta \nabla$] to select “Recently Played”, then press [ENTER] or [▷].
- 2** Use [$\Delta \nabla$] to select the item you want to play, then press [ENTER] or [▷].

NOTE
 Up to 20 stations stored in “Recently Played”

Registering Internet Radio Stations as Your Favorites

Press [PROGRAM] while the Internet radio station you want to register is playing.

Listening to Internet Radio Stations Registered in Your Favorites

- 1** Use [$\Delta \nabla$] to select “Favorites”, then press [ENTER] or [▷].
- 2** Use [$\Delta \nabla$] to select the Internet radio station, then press [ENTER] or [▷].
 The S-302 automatically connects to the Internet and playback begins.

Clearing Internet Radio Stations from Your Favorites

- 1** Use [$\Delta \nabla$] to select “Favorites”, then press [ENTER] or [▷].
- 2** Use [$\Delta \nabla$] to select the item you want to clear.
- 3** Press [CLEAR].
 “Clear to Favorite” appears on the display.
- 4** Use [◀ ▷] to select “Yes”, then press [ENTER].

Playing Files Stored on a Computer
 Use this procedure to play music files, image files or playlists.

- 1** Use [$\Delta \nabla$] to select the host name of the computer on which the music file you want to play is located, then press [ENTER] or [▷].
- 2** Use [$\Delta \nabla$] to select the search item or folder, then press [ENTER] or [▷].
 A “M” mark is indicated in front of music files that can be played, and a “I” mark is indicated in front of image files that can be played.
- 3** Use [$\Delta \nabla$] to select the file, then press [ENTER] or [▷].
 Playback starts once buffering reaches “100%”.

Selecting tracks

During playback, either press [◀◀] (previous track) or [▶▶] (next track).



- Connections to the required system and specific settings must be made in order to play music files (page 15).
- Before starting, you must launch the computer's server software and set the files as server contents. For details, see the operating instructions of your server software.
- Depending on the size of the still picture (JPEG) file, some time may be required for the file to be displayed.

Playing files that have been Registered in Your Favorites

Files can be preset, registered in your favorites and played using the same operations as for Internet radio stations.

NOTE

- When the operation described below is performed, the music server's database is updated and it may no longer be possible to play or favorite music files.
- When you quit the music server and then restart it.
- When music files are deleted or added on the music server.
- When using an ESCIENT server, place "ESCIENT" before the server name.

Playing Files Stored on USB Memory Devices

Only USB memory devices conforming to mass storage class and MTP (Media Transfer Protocol) standards can be played on the S-302.

Basic Operation

1 Make the necessary preparations.

- Set the USB port to be used.

GUI: "NET/USB"- "USB" (page 17)

- Connect the USB memory device to the set USB port.

2 Use [△▽] to select "USB", then press [ENTER] or [▷].

3 Use [△▽] to select the search item or folder, then press [ENTER] or [▷].

A "▶" mark is indicated in front of music files that can be played, and a "🖼️" mark is indicated in front of image files that can be played.

4 Use [△▽] to select the file, then press [ENTER] or [▷].

Playback starts once buffering reaches "100%".



Depending on the size of the still picture (JPEG) file, some time may be required for the file to be displayed.

Playing repeatedly

Press [REPEAT] on the remote control unit.

Playing in random order

Press [RANDOM] on the remote control unit. (Only valid in the stop mode)

Selecting tracks

During playback, either press [CHANNEL-] (previous track) or [CHANNEL+] (next track).



- If the USB memory device is divided into multiple partitions, only the top partition can be selected.
- The S-302 is compatible with MP3 files conforming to "MPEG-1 Audio Layer-3" standards.

NOTE

- DENON will take no responsibility whatsoever for any loss or damage to data on USB memory devices when using the USB memory device connected to the S-302.
- USB memory devices will not work via a USB hub.
- DENON does not guarantee that all USB memory devices will operate or receive power. When using a USB connection type portable hard disk of the type for which power can be supplied by connecting an AC adapter, we recommend using the AC adapter.
- It is not possible to connect and use a computer via the S-302's USB port using a USB cable.
- The S-302 is not compatible with the iPod shuffle.

Playing a Portable Audio

Your portable audio player can be connected to the S-302's portable jack to play tracks on the portable audio player.

1 Use <FUNCTION> or [AUX] to select "Front in".

GUI: "Front in" (page 17)

2 Play the portable audio player.

The Portable Audio are output.

※ Also read the portable audio player's operating instructions.

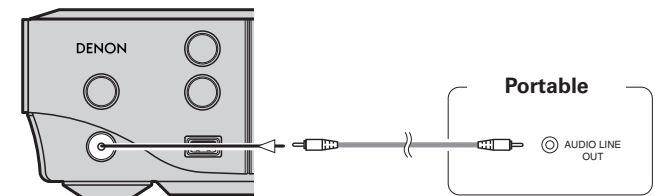

Connect the S-302 and portable audio player using a separately sold mini-stereo audio cable.

Advanced Operation

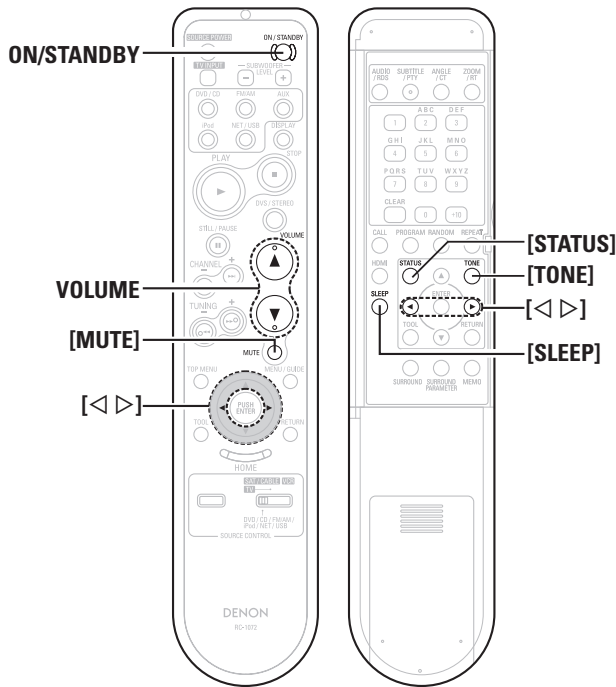
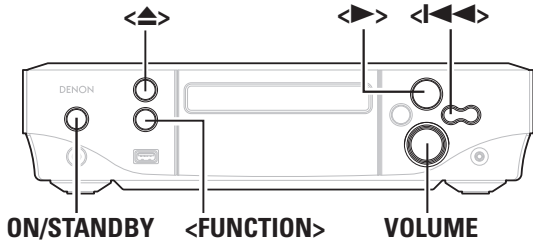

About the button names in these explanations

< > : Buttons on the main unit
 [] : Buttons on the remote control unit
Button name only:
 Buttons on the main unit and remote control unit

Setting the Sleep Timer

Use this function to automatically switch the power to the standby mode after a specific amount of time (minutes).

1 Set the current time (☞ page 22).

GUI : "SETUP" - "TIMER" - "Set Time" (☞ page 22)

2 During playback, use [SLEEP] to select the time. The "SLEEP" indicator flashes.

120 → 90 → 60 → 50 → 40 → 30 → 20 → 10
 "SLEEP" indicator off

※ After about 4 seconds, the "SLEEP" indicator stops flashing, remaining lit, and the settings are automatically entered.

3 The power is set to the standby mode after the set amount of time.

Canceling the sleep timer

Press [SLEEP] until the "SLEEP" indicator turns off.

※ The sleep timer can also be canceled by setting the S-302's power to the standby mode using ON/STANDBY.

Checking the time remaining until the sleep timer starts

In the stop mode, press [STATUS]. The time is displayed.

※ The time can be displayed by pressing [STATUS] when the power is in the standby mode. (When this is done, the set is no longer in the low power consumption standby mode.)

When pressed twice while the time is displayed, the display turns off and the set is put back in the low power consumption standby mode.

If the sleep timer and everyday timer settings overlap, the sleep timer has priority.

Other Functions

Adjusting the Tone

1 Select the adjustment mode using [TONE].

→ BASS → TREBLE → DEFEAT →

2 With the name of the item to be adjusted selected, press [< >] to adjust the level.

[Selectable mode]

BASS :

Adjusts the bass sound (-10 dB to +10 dB).

TREBLE :

Adjusts the treble sound (-10 dB to +10 dB).

DEFEAT :

The tone adjustment circuitry can be bypassed to achieve high sound quality. "0dB"



If no operation is performed within 4 seconds, the display switches back to what was previously displayed.

Turning the Sound Off Temporarily (Muting)

Press [MUTE].



To cancel, either press [MUTE] again or adjust the volume using VOLUME.

Convenient Functions

Personal Memory Plus Function

This function sets the settings (input mode, surround mode, etc.) last selected for the individual input sources. When you switch to an input source, the settings are automatically set to the ones that were set the last time that input source was used.



The surround parameters, tone adjustment and the volumes of the different speakers are stored for the individual surround modes.

Last Function Memory

This stores the settings as they were directly before the standby mode was set. When the power is turned back on, the settings are restored to as they were directly before the standby mode was set.

Backup Memory

The various settings are backed up for about 1 week, even if the power is turned off or the power cord is disconnected.

Auto Power On

When the power is in the standby mode, the power turns on simply by pressing <▲> or <▶>.

Resetting the Microprocessor

Perform this procedure if the display is abnormal or if operations cannot be performed. When the microprocessor is reset, all the settings are reset to their default values.

1 Set the standby mode using <ON/STANDBY> .

※ Set to the standby mode and wait 5 seconds.

2 Press <ON/STANDBY> while simultaneously pressing <FUNCTION> and <|◀◀>.

3 Once the display starts flashing at intervals of about 1 second, release the three buttons.



If in step 3 the display does not flash at intervals of about 1 second, start over from step 1.

Remote Control Unit Operations

Signal transmission indicator

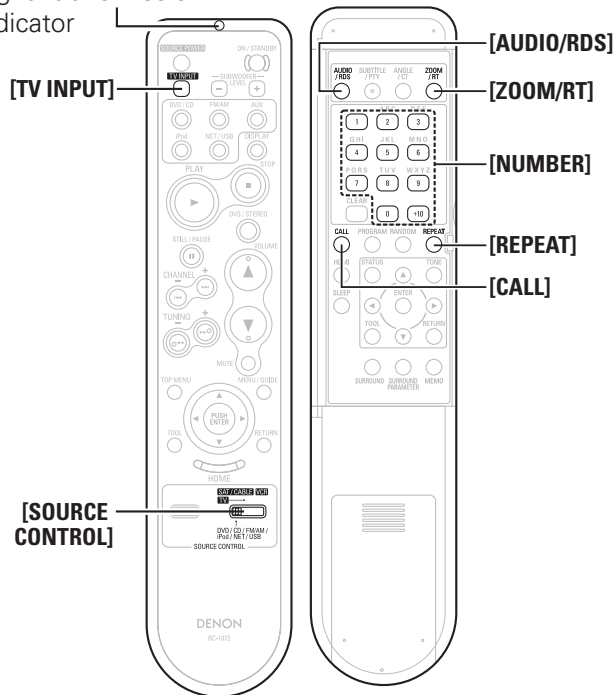

[SOURCE CONTROL]

About the button names in these explanations
 < > : Buttons on the main unit
 [] : Buttons on the remote control unit
Button name only:
 Buttons on the main unit and remote control unit

Setting the preset memory function

DENON and other makers of components can be operated by setting the preset memory. This remote control unit can be used to operate components of other manufacturers without using the learning function by registering the manufacturer of the component as shown in the list of preset codes (End of this manual).

- 1** Set [SOURCE CONTROL] to the component to be registered.
- 2** Press [AUDIO/RDS] and [ZOOM/RT] at the same time. The indicator starts flashing.
- 3** Referring to the included list of preset codes (End of this manual), press [NUMBER] (0 ~ 9) to input the preset code (a 3-digit number) for the manufacturer of the component whose signals you want to store in the memory.
- 4** To store the codes of another component in the memory, repeat steps 2 to 3.



- The signals for the pressed buttons are emitted while setting the preset memory. To avoid accidental operation, cover the remote control unit's transmitting window while setting the preset memory.
- Depending on the model and year of manufacture, this function cannot be used for some models, even if they are of makes listed in the list of preset codes.
- Some manufacturers use more than one type of remote control code. Refer to the included list of preset codes to change the number and verify correct operation.
- Operation is not possible for some models.

Operating a component stored in the preset memory

1 Set [SOURCE CONTROL] to the component you want to operate.

2 Operate the component.

- ※ For details, refer to the component's operating instructions.
- ※ Some models cannot be operated with this remote control unit.

Setting the punch through function

"Punch Through" is a function allowing you to operate [SOURCE CONTROL] and [TV INPUT] on "TV"; "SAT/CABLE" or "VCR" components when in the "DVD / CD / FM/AM / iPod NET/USB" mode. By default, nothing is set.

1 Set [SOURCE CONTROL] to the component to be registered (DVD / CD / FM/AM / iPod NET/USB).

2 Press [CALL] and [REPEAT] at the same time. The indicator starts flashing.

3 Input the number of the component you want to set.

	Number
TV	1
SAT/CABLE	2
VCR	3
No setting	0

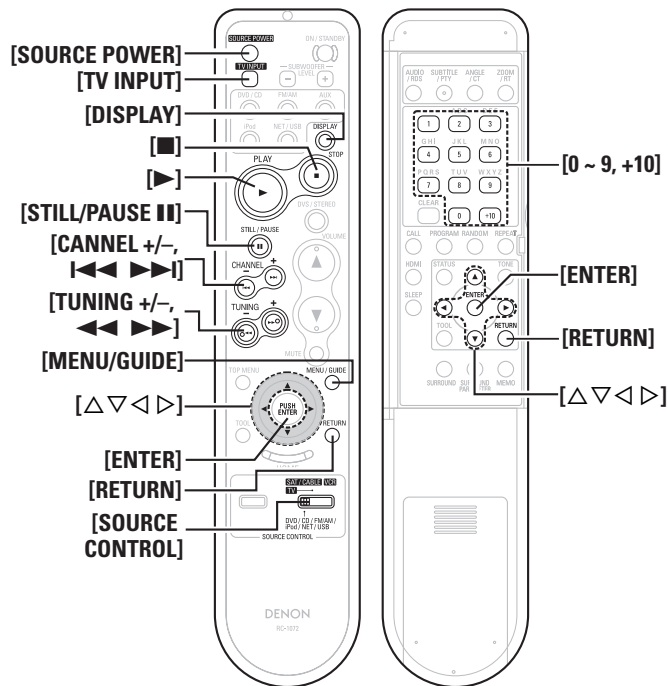

Functions of Buttons by Component

[Front]

Device operated	DVD/CD	iPod	NET/USB	TUNER	TV	Satellite Receiver, Cable TV	Video cassette recorder
SOURCE CONTROL	DVD / CD / FM/AM / iPod / NET/USB	DVD / CD / FM/AM / iPod / NET/USB	DVD / CD / FM/AM / iPod / NET/USB	DVD / CD / FM/AM / iPod / NET/USB	TV	SAT/CABLE	VCR
SOURCE POWER	Punch through	Punch through	Punch through	Punch through	Power on / off	Power on / off	Power on / off
TV INPUT	Punch through	Punch through	Punch through	Punch through	Input mode selection	Input mode selection	Input mode selection
DISPLAY	Display	Display	Display	–	Display	Display	–
▶	Playback	Playback	Playback	DVD/CD Playback Auto Preset (Hold)	–	–	Playback
■	Stop	–	Stop	–	–	–	Stop
STILL / PAUSE ■■	Still / Pause	Still / Pause	Still / Pause	–	–	–	Pause
◀▶▶▶, CHANNEL +/-	Auto search (cue)	Auto search (cue)	Auto search (cue)	Switch channels	Switch channels	Switch channels	Switch channels
◀▶▶▶, TUNING +/-	Manual search (fast-reverse/fast-forward)	Manual search (fast-reverse/fast-forward)	Manual search (fast-reverse/fast-forward)	Tuning	–	–	Search (reverse, forward)
MENU/GUIDE	Menu / Guide	Menu	–	–	Menu / Guide	Menu	–
△ ▽ ◀ ▶	Cursor	Cursor	Cursor	Cursor	Cursor	Cursor	–
ENTER	Enter	Enter	Enter	Enter	Enter	Enter	–
RETURN	–	Browse/Remote	Return	–	–	Return	–
Special remarks	①, ②	①, ②	①, ②	①, ②	①	①	①

[Rear]

Device operated	DVD/CD	iPod	NET/USB	TUNER	TV	Satellite Receiver, Cable TV	Video cassette recorder
SOURCE CONTROL	DVD / CD / FM/AM / iPod / NET/USB	DVD / CD / FM/AM / iPod / NET/USB	DVD / CD / FM/AM / iPod / NET/USB	DVD / CD / FM/AM / iPod / NET/USB	TV	SAT/CABLE	VCR
0 ~ 9, +10	Number input / Track selection	–	–	Channel selection	Channel selection	Channel selection	Channel selection
△ ▽ ◀ ▶	Cursor	Cursor	Cursor	Cursor	Cursor	Cursor	–
ENTER	Enter	Enter	Enter	Enter	Enter	Enter	–
RETURN	–	Browse/Remote	Return	–	–	Return	–
Special remarks	①	①	①	①	①	①	①

[Special Remarks]

- ① Only one component can be preset for each mode. If a new code is preset, the previous code is automatically cleared.
- ② The TV, SAT/CABLE or VCR buttons can be assigned to a DVD, CD, TUNER, iPod or NET/USB (page 40).

Other Information

Surround

The S-302 is equipped with a digital signal processing circuit that lets you play program sources in the surround mode to achieve the same sense of presence as in a movie theater.

Dolby Surround

Dolby Digital

Dolby Digital is a multichannel digital signal format developed by Dolby Laboratories.

A total of 5.1-channels are played: 3 front channels ("FL", "FR" and "C"), 2 surround channels ("SL" and "SR") and the "LFE" channel for low frequencies.

Because of this, there is no crosstalk between channels and a realistic sound field with a "three-dimensional" feeling (sense of distance, movement and positioning) is achieved.

A real, overpowering sense of presence is achieved when playing movie sources in AV rooms as well.

Dolby Pro Logic II

Dolby Pro Logic II is a matrix decoding technology developed by Dolby Laboratories.

Regular music such as that on CDs is encoded into 5-channels to achieve an excellent surround effect.

The surround channel signals are converted into stereo and full band signals (with a frequency response of 20 Hz to 20 kHz or greater) to create a "three-dimensional" sound image offering a rich sense of presence for all stereo sources.

※ Sources recorded in Dolby Surround

Sources recorded in Dolby Surround are indicated with the following logo marks.

Dolby Surround support mark : 

Manufactured under license from Dolby Laboratories. "Dolby," "Pro Logic" and the double-D symbol are trademarks of Dolby Laboratories.

DTS Surround

DTS Digital Surround

DTS Digital Surround is the standard digital surround format of DTS, Inc., compatible with a sampling frequency of 44.1 or 48 kHz and up to 5.1-channels of digital discrete surround sound.

Manufactured under license under U.S. Patent #'s: 5,451,942; 5,956,674; 5,974,380; 5,978,762; 6,487,535 & other U.S. and worldwide patents issued & pending. DTS is a registered trademark and the DTS logos, Symbol and DTS Virtual are trademarks of DTS, Inc. © 1996-2007 DTS, Inc. All Rights Reserved.

Dolby Headphone

Dolby Headphone is a 3D sound technology developed jointly by Dolby Laboratories and Lake Technology of Australia achieving surround sound with regular headphones.

Dolby Headphone simulates speaker playback in a room and positions the sound sources to the front or the sides, outside of the head, achieving a powerful sound similar to that of a movie theater or home theater.

Dolby Virtual Speaker

Dolby Virtual Speaker technology uses proprietary technology of Dolby Laboratories to create a virtual surround sound field using only two speakers for the front channels, allowing the user to experience sound as if surround speakers were actually being used.

Features of Dolby Virtual Speaker sound

Accurate surround sound field positioning

The virtual surround speakers are positioned at 105° to the left and 105° to the right.

Multi-channel programs played according to the producer's intentions

Sound set at the rear left is heard from the rear left.

Stereo programs played in surround

The Dolby Pro Logic II circuit is used together with the Dolby Virtual Speaker circuitry to create a rich virtual surround sound field with stereo programs as well.

Selecting the listening mode

Two listening modes are provided: Reference and Wide.

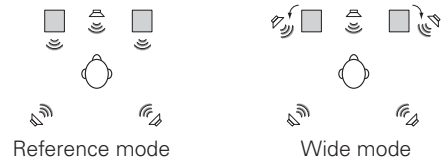

 : 2 front channels

 : Virtual sound field created with the Dolby Virtual Speaker mode

Surround Modes and Parameters

Surround Mode DVS: Dolby Virtual Speaker DHP: Dolby Headphone (H/P only)		Presence/absence of signals and controllability in the various modes								
		Channel output		Input signal per input source						
		FRONT L/R	SUB- WOOFER	DVD / NET/USB / AUX1, 2				AUX1, 2, 3 / TUNER / iPod / Portable		
				DOLBY DIGITAL		DTS		PCM	ANALOG	
		2-channel	Multi channel	2-channel	Multi channel	2-channel	2-channel			
DVS	REFERENCE	○	○	● PLII	○	● PLII	○	● PLII	● PLII	
	WIDE	○	○	● PLII	○	● PLII	○	● PLII	● PLII	
DHP	DOLBY H/P	×	×	● PLII	○	● PLII	○	● PLII	● PLII	
	BYPASS	×	×	○	○ D.MIX	○	○ D.MIX	○	○	
STEREO		○	○	○	○ D.MIX	○	○ D.MIX	○	○	
ROCK ARENA		○	○	○	○	○	○	○	○	
JAZZ CLUB		○	○	○	○	○	○	○	○	

Surround Mode		Source	Surround parameter (default)			TONE CONTROL
			Cinema/ Music	D.COMP DOLBY DIGITAL/DTS only	LFE	
DVS	REFERENCE		×	○ (OFF)	○ (0dB)	○ (OFF)
	WIDE		×	○ (OFF)	○ (0dB)	○ (OFF)
DHP	DOLBY H/P	Multich	×	○ (OFF)	○ (0dB)	○ (OFF)
		2ch	○ (CINEMA)	○ (OFF)	○ (0dB)	○ (OFF)
	BYPASS		×	○ (OFF)	○ (0dB)	○ (OFF)
STEREO			×	○ (OFF)	○ (0dB)	○ (OFF)
ROCK ARENA			×	○ (OFF)	○ (0dB)	○ (OFF)
JAZZ CLUB			×	○ (OFF)	○ (0dB)	○ (OFF)

- : Signal present or controllable.
- : Can be selected with 2-channel decode mode.
- ×
- ×
- D.MIX : Compatible with down-mixing.
- PLII : Compatible with PLII processing.

Video output table

Slide Switch Position		Interface										Progressive					HDMI								
OUTPUT	VIDEO	S-video	Component					HDMI	VIDEO	S-video	Component					HDMI	VIDEO	S-video	Component	HDMI					
			480i/576i	480p/576p	720p	1080i	1080p				480i/576i	480p/576p	720p	1080i	1080p					480p/576p	720p	1080i	1080p	1080p	
DVD/CD	○	○	○	×	×	×	×	×	○	○	×	○	×	×	×	×	×	○	○	×	○	○	○	○	○
TUNER	△	△	△	×	×	×	×	×	△	△	△	×	×	×	×	×	×	△	△	×	△	△	△	△	△
AUX1	VIDEO	○	○	○	×	×	×	×	○	○	○	×	×	×	×	×	×	○	○	×	○	○	○	○	○
	S-video	○	○	○	×	×	×	×	○	○	○	×	×	×	×	×	×	○	○	×	○	○	○	○	○
	480i/576i	○	○	○	×	×	×	×	○	○	○	×	×	×	×	×	×	○	○	×	○	○	○	○	○
	480p/576p	×	×	×	○	×	×	×	×	×	×	○	×	×	×	×	×	×	×	×	×	○	○	○	○
	720p	×	×	×	×	○	×	×	×	×	×	×	○	×	×	×	×	×	×	×	×	×	○	○	○
1080i	×	×	×	×	×	○	×	×	×	×	×	×	×	○	×	×	×	×	×	×	×	○	○	○	
1080p	×	×	×	×	×	×	○*1	×	×	×	×	×	×	×	○*1	×	×	×	×	×	×	×	×	×	
AUX 2	Video	○	○	○	×	×	×	×	○	○	○	×	×	×	×	×	×	○	○	×	○	○	○	○	○
	S-video	○	○	○	×	×	×	×	○	○	○	×	×	×	×	×	×	○	○	×	○	○	○	○	○
AUX 3	line L/R	△	△	△	×	×	×	×	△	△	△	×	×	×	×	×	×	△	△	×	△	△	△	△	△
Front in		△	△	△	×	×	×	×	△	△	△	×	×	×	×	×	×	△	△	×	△	△	△	△	△
iPod	Connector	○	○	○	×	×	×	×	○	○	○	×	×	×	×	×	×	○	○	×	○	○	○	○	○
	dock	○	○	○	×	×	×	×	○	○	○	×	×	×	×	×	×	○	○	×	○	○	○	○	○
NET/ USB	USB playback	○	○	○	×	×	×	×	○	○	○	×	×	×	×	×	×	○	○	×	○	○	○	○	○
	internet Radio	○	○	○	×	×	×	×	○	○	○	×	×	×	×	×	×	○	○	×	○	○	○	○	○
	DLNA client	○	○	○	×	×	×	×	○	○	○	×	×	×	×	×	×	○	○	×	○	○	○	○	○

- : Video output.
- △ : Only OSD output.
- * 1: No OSD (through only)
- * 2: If the AUTO setting is lower than the input signal when the input signal is 720p/1080i, the signal is output according to the input resolution.

Progressive Scan Circuit "DCDi™"

"DCDi™" is trademark of Faroodja, a division of Genesis Microchip Inc. The S-302 is equipped with a high precision Progressive Scan circuit "DCDi™" allowing it to reproduce movies and other images on DVDs with a quality near that of the original.

AL24 Processing (Stereo mode only)

AL24 Processing has inherited the technology of the original ALPHA Processing that was used in DENON's highly-successful reference-class audio components. AL24 Processing further reduces quantization distortion and represents the ultimate analog waveform reproduction technology designed to support the higher numbers of bits and higher sampling. AL24 Processing senses the nature of the digital data being input and interpolates the data so that it faithfully replicates the original analog waveform. AL24 processing operates when CD, MP3 or WMA data is inputted.

HDCD® (High Definition Compatible Digital®) (Stereo mode only)

HDCD® is an encoding/decoding technology that greatly reduces the distortion that occurs upon digital recording while maintaining compatibility with the conventional CD format, thus expanding the dynamic range and achieving a high resolution. Conventional CDs and HDCD compatible CDs are identified automatically to select the optimum digital processing.

HDCD®, HDCD®, High Definition Compatible Digital® and Microsoft® are either registered trademarks or trademarks of Microsoft Corporation, Inc. in the United States and/or other countries. HDCD system manufactured under license from Microsoft Corporation, Inc. This product is covered by one or more of the following: In the USA: 5,479,168, 5,638,074, 5,640,161, 5,808,574, 5,838,274, 5,854,600, 5,864,311, 5,872,531, and in Australia: 669114. Other patents pending.

Audyssey Dynamic EQ.

Audyssey Dynamic EQ. is a technology that automatically corrects the tonal balance of an audio system when the volume is changed. It is based on psychoacoustic research that better matches to human perception than other loudness compensation that was used before. The tonal balance is adjusted continuously with variation in both program material and volume setting.

Audyssey BassXT

Audyssey BassXT is a solution to extend bass performance to lower frequencies without increasing cabinet size, driver size or weight. BassXT actively monitors the incoming low frequency signal and drives subwoofers to their maximum capability at all volumes, thereby producing deeper bass at all volume levels. This allows the subwoofer to play low bass content when it can and protects it only for the few times when it can't. It is not like simple bass boost or tone control as the system is fully customized for each speaker design by DSP processing and works in real time.

Manufactured under license from Audyssey Laboratories, Inc. U.S. and foreign patents pending. Audyssey BassXT™ and Audyssey Dynamic EQ™ are trademarks of Audyssey Laboratories, Inc.

About Networks

Windows Media Player Ver.11

This is a media player distributed free of charge by Microsoft Corporation. It can be used to play playlists created with Windows Media Player Ver. 11 as well as files in such formats as WMA, DRM WMA, MP3 and WAV.

vTuner

This is a free online contents server for Internet radio. Note that usage fees are included in upgrade costs. For inquiries about this service, visit the vTuner site below. vTuner website: <http://www.radiodenon.com>

This product is protected by certain intellectual property rights of Nothing Else Matters Software and BridgeCo. Use or distribution of such technology outside of this product is prohibited without a license from Nothing Else Matters Software and BridgeCo or an authorized subsidiary.

DLNA

- DLNA and DLNA CERTIFIED are trademarks and/or service marks of Digital Living Network Alliance.
- Some contents may not be compatible with other DLNA CERTIFIED™ products.

Windows Media DRM

A copyright-protected technology developed by Microsoft.

- Windows Vista and the Windows logo are trademarks of the Microsoft group of companies.
- The PlaysForSure logo, Windows Media and the Windows logo are trademarks or registered trademarks of Microsoft Corporation in the United States and/or other countries.
- Content providers are using the digital rights management technology for Windows Media contained in this device (WM-DRM) to protect the integrity of their content (Secure Content) so that their intellectual property, including copyright, in such content is not misappropriated. This device uses WM-DRM software to play Secure Content (WM-DRM Software). If the security of the WM-DRM Software in this device has been compromised, owners of Secure Content (Secure Content Owners) may request that Microsoft revoke the WM-DRM Software's right to acquire new licenses to copy, display and/or play Secure Content. Revocation does not alter the WM-DRM Software's ability to play unprotected content. A list of revoked WM-DRM Software is sent to your device whenever you download a license for Secure Content from the Internet or from a PC. Microsoft may, in conjunction with such license, also download revocation list onto your device on behalf of Secure Content Owners.

About Wireless LAN

Wi-Fi®

Wi-Fi Certification assures tested and proven interoperability by the Wi-Fi Alliance, a group certifying interoperability among wireless LAN devices.

IEEE 802.11b

This is one wireless LAN standard set by the 802 working group that establishes LAN technology standards at the IEEE (Institute of Electrical and Electronics Engineers) of the United States. It uses the 2.4 GHz band usable freely without a radio frequency license (ISM band), enabling communications at a maximum speed of 11 Mbps.



The value indicated above is the maximum theoretical value for the wireless LAN standard, and does not indicate the actual data transfer rate.

IEEE 802.11g

This is another wireless LAN standard set by the 802 working group that establishes LAN technology standards at the IEEE (Institute of Electrical and Electronics Engineers) of the United States, and is compatible with IEEE 802.11b. It also uses the 2.4 GHz band, but enables communications at a maximum speed of 54 Mbps.



The value indicated above is the maximum theoretical value for the wireless LAN standard, and does not indicate the actual data transfer rate.

Infrastructure Communications

"Infrastructure Communications" refers to networks using wireless LAN access points.

This function can be used to connect to the Internet or a wired LAN via a wireless LAN access point. Wireless LAN access points include wireless broadband routers.

Ad-hoc Communications

Signal transfer through wireless interconnection of computers is referred to as "ad hoc communications." With such ad hoc communications there is no connection to the Internet. Ad hoc communications are suited for establishing simple temporary networks.

Network Names (SSID: Security Set Identifier)

When forming wireless LAN networks, groups are formed to prevent interference, data theft, etc. This grouping is done by "SSID" or "Security Set Identifiers." For further security, a WEP key is set and signal transfer is not possible unless the SSID and WEP key match.

WEP Key (Network Key)

This is key information used for encrypting data when conducting data transfer. On the S-302, the same WEP key is used for data encryption and decryption, so the same WEP key must be set on both devices in order for communications to be established between them.

WPA (Wi-Fi Protected Access)

This is a security standard established by the Wi-Fi Alliance. In addition to the conventional SSID (network name) and WEP key (network key), it also uses a user identification function and encrypting protocol for stronger security.

WPA2 (Wi-Fi Protected Access 2)

This is a new version of the WPA established by the Wi-Fi Alliance, compatible with more secure AES encryption.

WPA-PSK/WPA2-PSK (Pre-shared Key)

This is a simple authentication system for mutual authentication when a preset character string matches on the wireless LAN access point and client.

Passphrase

This refers to the code key used for WPA-PSK/WPA2-PSK authentication, a WPA authentication method.

TKIP (Temporal Key Integrity Protocol)

This is a network key used for WPA. The encryption algorithm is RC4, the same as for WEP, but the security level is increased by changing the network key used for encryption for each packet.

AES (Advanced Encryption Standard)

This is a next generation standard encryption method replacing the current DES and 3DES, and because of its high security it is expected to be applied widely to wireless LANs in the future. It uses the "Rijndael" algorithm developed by two Belgian cryptographers to divide the data into blocks of fixed lengths and encrypt each block. It supports data lengths of 128, 192 and 256 bits and key lengths of 128, 192 and 256 bits as well, offering extremely high encryption security.

Troubleshooting

If a problem should arise, first check the following:

1. Are the connections correct?
2. Is the set being operated as described in the owner's manual?
3. Are the other components operating properly?

If this unit does not operate properly, check the items listed in the table below. Should the problem persist, there may be a malfunction.

In this case, disconnect the power immediately and contact your store of purchase.

[General]

Symptom	Cause	Countermeasure	Page
Display not lit and sound not produced when power switch set to on.	<ul style="list-style-type: none"> Power cord not plugged in securely. 	<ul style="list-style-type: none"> Check the insertion of the power cord plug. 	10
Display lit but sound not produced.	<ul style="list-style-type: none"> Speaker cables not securely connected. Device you want to play and set input source do not match. Volume control set to minimum. MUTING is on. Digital signals not input Digital input selected. 	<ul style="list-style-type: none"> Connect securely. Select an appropriate input source. Turn volume up to suitable level. Switch off MUTING. Input digital signals or select input terminal to which digital signals are being input. 	10 24 24 38 13
Monitor does not display an image.	<ul style="list-style-type: none"> Connections between the video output terminal of this unit and the input connector of the monitor are incomplete. The input setting of the monitor TV is different. 	<ul style="list-style-type: none"> Check whether the connections are correct. 	11
		<ul style="list-style-type: none"> Set the input switching of the TV to the terminal to which the video input is connected. 	11
When the subwoofer indicator has lit.	<ul style="list-style-type: none"> The subwoofer and main unit are not properly connected with the system cable. 	<ul style="list-style-type: none"> Check whether or not the cable is properly connected. If the indicator lights even though the cable is properly connected, there may be a malfunction. 	10

Symptom	Cause	Countermeasure	Page
Power turns off suddenly and power indicator flashes red.	<ul style="list-style-type: none"> Protection circuit activated due to rise of internal temperature. 	<ul style="list-style-type: none"> Turn off the power, wait for the set to fully cool down, then turn the power back on. 	11
	<ul style="list-style-type: none"> Core wires of two speakers are touching each other or a core wire is sticking out of the terminal and touching the set's rear panel, activating the protection circuit. 	<ul style="list-style-type: none"> Place the set in a well-ventilated place. First unplug the power cord, then twist the core wires tightly or terminate the speaker cables, then reconnect. 	11
	<ul style="list-style-type: none"> Set is damaged. 	<ul style="list-style-type: none"> Turn off the power and contact a DENON service center. 	9
			–

[Remote Control Unit]

Symptom	Cause	Countermeasure	Page
Set does not work properly when remote control unit operated.	<ul style="list-style-type: none"> Batteries are worn. 	<ul style="list-style-type: none"> Replace with new batteries. 	5
	<ul style="list-style-type: none"> You are operating outside of the specified range. 	<ul style="list-style-type: none"> Operate within the specified range. 	5
	<ul style="list-style-type: none"> Obstacle between main unit and remote control unit. 	<ul style="list-style-type: none"> Remove the obstacle. 	5
	<ul style="list-style-type: none"> The batteries are not inserted in the proper direction, as indicated by the polarity marks in the battery compartment. 	<ul style="list-style-type: none"> Insert the batteries in the proper direction, following the polarity marks in the battery compartment. 	5
	<ul style="list-style-type: none"> The set's remote control sensor is exposed to strong light (direct sunlight, inverter type fluorescent bulb light, etc.). 	<ul style="list-style-type: none"> Move the set to a place in which the remote control sensor will not be exposed to strong light. 	5
	<ul style="list-style-type: none"> SOURCE CONTROL switch position is different. 	<ul style="list-style-type: none"> Set the SOURCE CONTROL switch for the device you wish to use. 	8

[DVD]

Symptom	Countermeasure	Page
Playback does not start when ► button is pressed. Playback stops immediately.	<ul style="list-style-type: none"> • Is there condensation on the disc or player ? (Let stand for 1 or 2 hours.) • Discs other than DVDs and music CDs cannot be played. • Disc is dirty. Wipe off the dirt. 	– 4 5
Picture is disturbed during the search operation.	<ul style="list-style-type: none"> • Some disturbance is normal. 	–
Buttons do not operate.	<ul style="list-style-type: none"> • Some operations are disabled for some discs. 	–
No subtitles are displayed.	<ul style="list-style-type: none"> • Subtitles are not displayed for DVDs not containing subtitles. • Subtitles are turned off. Turn the subtitles setting on. 	– 18
Audio (or subtitle) language does not switch.	<ul style="list-style-type: none"> • The audio (or subtitle) language does not switch for discs which do not include multiple audio (or subtitle) languages. • For some discs the audio (or subtitle) language cannot be switched when the operation to switch it is performed, but can be switched on the menu screens. 	– 26
Angle does not switch.	<ul style="list-style-type: none"> • The angle cannot be switched for DVDs which do not contain multiple angles. In some cases multiple angles are only recorded for specific scenes. 	–
Playback does not start when the title is selected.	<ul style="list-style-type: none"> • Check the "RATINGS" setting. 	22
The password for rating level has been forgotten. Reset all the DVD setting to Factory Preset.	<ul style="list-style-type: none"> • Initialize using the procedure described at "Resetting the Microprocessor". 	39
The disc is not played with the audio or subtitle language set as the default setting.	<ul style="list-style-type: none"> • The disc does not play with the selected audio or subtitle language if that audio or subtitle language is not included on that DVD. 	18
Picture is not displayed in 4:3 (or 16:9).	<ul style="list-style-type: none"> • At the GUI menu's "TV Aspect" setting, select "Normal (4:3LB)/ Normal (4:3PS)/Wide (16:9)" and set according to the TV you are using. 	19

Symptom	Countermeasure	Page
Menu screen messages for the desired language do not display.	<ul style="list-style-type: none"> • Check the default setting for the disc language's menu language. 	18

[Audio]

Symptom	Cause	Countermeasure	Page
No sound is output from the monitor connected with HDMI connections.	<ul style="list-style-type: none"> • HDMI audio signal output destination setting is wrong. 	<ul style="list-style-type: none"> • Set to "Setup" – "Video Setup" – "HDMI Setup" – "HDMI Audio Out" – "On". 	19

[Tuner]

Symptom	Cause	Countermeasure	Page
Continuous noise is heard when receiving FM programs	<ul style="list-style-type: none"> • Antenna cable is not properly connected. 	<ul style="list-style-type: none"> • Connect the antenna cable properly. • Connect an outdoor antenna. 	14
Hissing or continuous noise is heard when receiving AM programs	<ul style="list-style-type: none"> • This may be noise from a TV or interference from a radio station. 	<ul style="list-style-type: none"> • Turn off the TV. • Change the position and direction of the AM loop antenna. 	–

[iPod]

Symptom	Cause	Countermeasure	Page
iPod cannot be played.	<ul style="list-style-type: none"> The input source assigned to "iPod Assign" is not selected. Cable is not properly connected. Control Dock for iPod's AC adapter is not connected to power outlet. 	<ul style="list-style-type: none"> Switch to the input source assigned at "Assign iPod." Reconnect. Plug the Control Dock for iPod's AC adapter into a power outlet. 	22 12, 13 -
iPod slide show is not output to the TV.	-	<ul style="list-style-type: none"> Set the iPod slide show correctly. See your iPod user's manual for more details on how to operate. 	-

[Video]

Symptom	Cause	Countermeasure	Page
The on-screen display does not appear.	<ul style="list-style-type: none"> The format of the GUI and TV (NTSC or PAL) do not match. 	<ul style="list-style-type: none"> Match the format of the GUI and TV. 	19
No picture appears.	<ul style="list-style-type: none"> The connections between the S-302 and monitor are faulty. The monitor's input setting is wrong. 	<ul style="list-style-type: none"> Check the connections. Set properly. 	11 -
No picture appears with HDMI connections.	<ul style="list-style-type: none"> The connections to the HDMI connectors are faulty. The monitor is not compatible with copyright protection (HDCP). 	<ul style="list-style-type: none"> Check the connections. Connect a monitor that is compatible with copyright protection (HDCP). 	11 12
DVDs cannot be copied on a VCR.	-	<ul style="list-style-type: none"> This is not a malfunction. Most movie software includes copy prevention signals and cannot be copied. 	-

[NET/USB]

Symptom	Cause	Countermeasure	Page
When a USB memory device is connected, "USB" is not displayed on the GUI menu.	<ul style="list-style-type: none"> The set cannot recognize a USB memory device. A USB memory device not conforming to mass storage class or MTP standards is connected. A USB memory device that the set cannot recognize is connected. USB memory device is connected via USB hub. 	<ul style="list-style-type: none"> Check the connection. Connect a USB memory device conforming to mass storage class or MTP standards. This is not a malfunction. DENON does not guarantee that all USB memory devices will operate or receive power. Connect the USB memory device directly to the USB port. 	13 - - -
Files on a USB memory device cannot be played.	<ul style="list-style-type: none"> USB memory device is in format other than FAT16 or FAT32. USB memory device is divided into multiple partitions. Files are stored in a non-compatible format. You are attempting to play a file that is copyright protected. 	<ul style="list-style-type: none"> Set the format to FAT16 or FAT32. For details, refer to the USB memory device's operating instructions. When divided into multiple partitions, only files stored in the top partition can be played. Record the files in a compatible format. Files that are copyright protected cannot be played on this set. 	- - 34 34
The file names are not displayed properly (".." etc.).	<ul style="list-style-type: none"> Characters that cannot be displayed are used. 	<ul style="list-style-type: none"> This is not a malfunction. On this set, characters that cannot be displayed are replaced with a "." (period). 	-
Files stored on a computer cannot be played.	<ul style="list-style-type: none"> Files are stored in a non-compatible format. You are attempting to play a file that is copyright protected. Set and computer are connected by USB cable. 	<ul style="list-style-type: none"> Record in a compatible format. Files that are copyright protected cannot be played on this set. The set's USB port cannot be used for connection to a computer. 	34 34 -

Symptom	Cause	Countermeasure	Page
Internet radio cannot be played.	<ul style="list-style-type: none"> Ethernet cable is not properly connected or network is disconnected. Program is being broadcast in non-compatible format. 	<ul style="list-style-type: none"> Check the connection status. 	15
		<ul style="list-style-type: none"> Only Internet radio programs in MP3 and WMA can be played on this set. 	-
	<ul style="list-style-type: none"> The computer's or router's firewall is activated. Radio station is not currently broadcasting. IP address is wrong. 	<ul style="list-style-type: none"> Check the computer's or router's firewall settings. Choose a radio station that is currently broadcasting. Check the set's IP address. 	-
		<ul style="list-style-type: none"> Check the computer's or router's firewall settings. Turn on the power. Launch the server. Check the set's IP address. 	35 20, 21
Server is not found, or it is not possible to connect to the server.	<ul style="list-style-type: none"> The computer's or router's firewall is activated. Computer's power is not turned on. Server is not running. Set's IP address is wrong. 	<ul style="list-style-type: none"> Check the computer's or router's firewall settings. Turn on the power. 	-
		<ul style="list-style-type: none"> Launch the server. Check the set's IP address. 	- 20, 21
Cannot connect to preset or favorite radio stations.	<ul style="list-style-type: none"> Radio station is not currently broadcasting. Radio station is not currently in service. 	<ul style="list-style-type: none"> Wait a while before trying again. 	-
		<ul style="list-style-type: none"> It is not possible to connect to radio stations that are no longer in service. 	-
For some radio stations, "Server Full" or "Connection Down" is displayed and station cannot be connected to.	<ul style="list-style-type: none"> Station is congested or not currently broadcasting. 	<ul style="list-style-type: none"> Wait a while before trying again. 	-
Sound is broken during playback.	<ul style="list-style-type: none"> Network's signal transfer speed is slow or communications lines or radio station is congested. 	<ul style="list-style-type: none"> This is not a malfunction. When playing broadcast data with a high bit rate, the sound may be broken, depending on the communications conditions. 	-
Sound quality is poor or played sound is noisy.	<ul style="list-style-type: none"> File being played has a low bit rate. 	<ul style="list-style-type: none"> This is not a malfunction. 	-

[Wireless LAN]

Symptom	Cause	Countermeasure	Page
Cannot connect to network.	<ul style="list-style-type: none"> The settings of the SSID and network key (WEP) are incorrect. The reception is poor and the signals cannot be received. 	<ul style="list-style-type: none"> Match the network settings with the S-302's settings. 	21
		<ul style="list-style-type: none"> Shorten the distance from the wireless LAN's access point, remove any obstacles and otherwise improve visibility, then try reconnecting. Also install away from microwave ovens and the access points of other networks. 	-
Played sound is interrupted or sound cannot be played.	<ul style="list-style-type: none"> There are multiple networks and the usable channels overlap. 	<ul style="list-style-type: none"> Set the access point's channel settings away from the channels used for other networks. Alternatively, connect using a network cable. 	-
		<ul style="list-style-type: none"> Set the access point's channel settings away from the channels used for other networks. Alternatively, connect using a network cable. 	-

Specifications

Audio section

Power amplifier

Rated output: Front:
50 W + 50 W (4 Ω/ohms)

Analog

Input sensitivity / Input impedance: 200 mV / 47 kΩ/kohms

Tuner section

Reception frequency range: FM: 87.50 MHz ~ 107.9 MHz AM: 520 kHz to 1710 kHz
Receiving sensitivity: FM: 1.5 μV/75 Ω/ohms AM: 20 μV
FM stereo separation: 35 dB (1 kHz)

Video section

Standard video connectors

Input / output level and impedance: 1 Vp-p, 75 Ω/ohms

S-Video connectors

Input / output level and impedance: Y (brightness) signal — 1 Vp-p, 75 Ω/ohms
C (color) signal — 0.286 Vp-p, 75 Ω/ohms

Color component video connector

Input / output level and impedance: Y (brightness) signal — 1 Vp-p, 75 Ω/ohms
P_B / C_B signal — 0.648 Vp-p, 75 Ω/ohms
P_R / C_R signal — 0.648 Vp-p, 75 Ω/ohms

Pin connector : 1 set/S-Video connector : 1 set/
Component video connector : 1 set

DVD section

Signal format: NTSC/PAL

Supported discs:
 (1) DVD-VIDEO discs
 12 cm single side 1 layer, 12 cm single side 2 layers,
 12 cm both sides 2 layers (single side 1 layer),
 8 cm single side 1 layer, 8 cm single side 2 layers,
 8 cm both sides 2 layers (single side 1 layer)
 (2) Compact Disc (CD-DA)
 12 cm discs, 8 cm discs

Clock/Timer section

Clock method:

Power line frequency synchronized method

Timer: Everyday/Once timer: One system each

Sleep timer: 120 minutes, maximum

General

Power supply: 120 V AC, 60 Hz

Power consumption: 78 W
0.3 W (standby)

Maximum external dimensions: 380 (W) x 97 (H) x 301 (D) mm (14-61/64" x 3-13/16" x 11-27/32")
(ADV-S302) (including system cable)

Weight: 4.3 kg (9 lbs 7 oz) (ADV-S302)

Remote control unit (RC-1072)

Remote control method: IR pulse method

Power supply: R6/AA Type (two batteries)

Maximum external dimensions: 52 (W) x 243 (H) x 21 (D) mm (2-3/64" x 9-9/16" x 13/16")

Weight: 175 g (Approx 6 oz) (including batteries)

Speakers

Speaker system

Type: SC-S302
2-way, 3-speakers, Closed box / Low-leakage-flux
8 cm cone bass-mid x 2 / 2 cm high range x 1
131 (W) x 335 (H) x 76 (D) mm (5-5/32" x 13-3/16" x 2-63/64")
Weight: 2.0 kg (4 lbs 14 oz) (per unit)

Subwoofer

Type: DSW-S302
1-way, 1-speaker, Reflex box / Low-leakage-flux / Built-in amplifier
16 cm cone x 1

Maximum external dimensions: 212 (W) x 378 (H) x 406 (D) mm (8-11/32" x 14-7/8" x 15-31/32")
(including foot)

Weight: 11.2 kg (24 lbs 11 oz) (including base)

Wireless LAN

Network type (wireless LAN standards) : Conforming to IEEE 802.11b

Conforming to IEEE 802.11g

(Conforming to Wi-Fi®)*

Transfer rate: DS-SS: 11 / 5.5 / 2 / 1 Mbps (Automatic switching)

OFDM: 54 / 48 / 36 / 24 / 18 / 12 / 9 / 6 Mbps (Automatic switching)

Security: SSID (Network name)

WEP key (network key) (64/128 bits)

WPA-PSK (TKIP/AES)

WPA2-PSK (TKIP/AES)

2,412 MHz ~ 2,462 MHz

Used frequency range: Conforming to IEEE 802.11b : 11ch (DS-SS) (Of which 1 channel used)

Conforming to IEEE 802.11g : 11ch (OFDM) (Of which 1 channel used)

* Wi-Fi® conformity indicates tested and proven interoperability by the "Wi-Fi Alliance", a group certifying interoperability among wireless LAN devices.

※ For purposes of improvement, specifications and design are subject to change without notice.

※ This product incorporates copyright protection technology that is protected by method claims of certain U.S. patents and other intellectual property rights owned by Macrovision Corporation and other rights owners. Use of this copyright protection technology must be authorized by Macrovision Corporation, and is intended for home and other limited viewing uses only unless otherwise authorized by Macrovision Corporation. Reverse engineering or disassembly is prohibited.

List of preset codes / Liste von voreingestellten Codes / Liste de codes pré-réglés / Lista dei codici pre-regolati / Lista de códigos pre-ajustados / Lijst van vooringestelde codes / Förteckning över förinställda koder

DVD Player

A	Aiwa	009
D	Denon	014, *[111]
H	Hitachi	010
J	JVC	006, 011
K	Konka	012, 013
M	Magnavox	005
	Mitsubishi	004
P	Panasonic	014
	Philips	005, 015, 016, 017
	Pioneer	003, 008
S	Sanyo	018
	Sony	002, 019, 020
T	Toshiba	001, 021, 022
Z	Zenith	023

VDP

D	Denon	028, 029, 112
M	Magnavox	026
	Mitsubishi	028
P	Panasonic	029, 030
	Philips	026
	Pioneer	028, 031
R	RCA	032
S	Sony	033, 034, 035, 036

VCR

A	Admiral	081
	Aiko	095
	Aiwa	009
	Akai	026, 027, 070, 072, 082, 083, 084
	Alba	055
	Amstrad	009
	ASA	042
	Asha	087
	Audio Dynamic	005, 085
	Audiovox	088
B	Beaumont	087
	Broksonic	086, 093
C	Calix	088
	Candle	006, 087, 088, 089, 090
	Canon	049, 057
	Capehart	025, 055, 056, 071
	Carver	015
	CCE	095

	Citizen	006, 007, 087, 088, 089, 090, 095
	Craig	007, 087, 088, 091, 115
	Curtis Mathes	006, 049, 073, 080, 087, 090, 092
	Cybernex	087
D	Daewoo	025, 055, 059, 074, 089, 093, 095, 096
	Daytron	025, 055
	DBX	005, 085
	Dumont	053
	Dynatech	009
E	Electrohome	001, 088, 097
	Electrohome	088
	Emerson	001, 009, 017, 027, 086, 088, 089, 092, 093, 097, 100, 101, 102, 103, 104, 117
F	Fisher	009, 028, 031, 053, 054, 091, 099, 115
G	GE	007, 011, 049, 050, 051, 052, 073, 080, 087
	Go Video	047, 048
	Goldstar	000, 006, 012, 062, 088
	Gradiente	094
	Grundig	042
H	Harley Davidson	094
	Harman Kardon	040, 062
	Hi-Q	091
	Hitachi	009, 013, 023, 026, 058, *[108], 109, 110, 111
J	JC Penny	004, 005, 007, 023, 028, 049, 062, 085, 087, 088
	Jensen	013, 026
	JVC	004, 005, 006, 026, 029, 043, 044, 045, 046, 085
K	Kenwood	004, 005, 006, 026, 029, 033, 045, 085, 090
	Kodak	088
L	Lloyd	009, 094
	LXI	088
M	Magnavox	015, 016, 042, 049, 063, 106
	Magnin	087
	Marantz	004, 005, 006, 015, 042, 049, 085, 090
	Marta	088
	MEI	049
	Memorex	009, 033, 049, 053, 060, 081, 087, 088, 091, 094, 115
	Metz	123, 124, 125, 126, 127, 128
	MGA	001, 017, 027, 041, 097
	MGN Technology	087
	Midland	011
	Minolta	013, 023

	Mitsubishi	001, 003, 008, 013, 014, 017, 027, 029, 039, 040, 041, 045, 097
	Motorola	081
	Montgomery Ward	001, 002, 007, 009, 049, 063, 081, 115, 117
	MTC	009, 087, 094
	Multitech	007, 009, 011, 087, 090, 094
N	NAD	038
	NEC	004, 005, 006, 018, 026, 029, 045, 061, 062, 085
	Nikko	088
	Noblex	087
O	Optimus	081, 088
	Optonica	021
P	Panasonic	024, 049, 064, 066, 067, 068, 069, 107
	Perdio	009
	Pentax	009, 013, 023, 058, 090
	Philco	015, 016, 049
	Philips	015, 021, 042, 049, 105
	Pilot	088
	Pioneer	005, 013, 029, 036, 037, 038, 045, 085
	Portland	025, 055, 090
	Proscan	063, 080
	Pulsar	060
Q	Quartz	033
	Quasar	034, 035, 049
R	Radio Shack	001, 002, 021, 081, 087, 088, 091, 094, 097, 098, 115
	Radix	088
	Randex	088
	RCA	007, 013, 019, 023, 058, 063, 064, 065, 073, 080, 082, 087
	Realistic	009, 021, 031, 033, 049, 053, 081, 087, 088, 091, 094, 097, 098
	Ricoh	055
S	Salora	033, 041
	Samsung	007, 011, 051, 059, 070, 083, 087, 089, 113
	Sanky	081
	Sansui	005, 026, 029, 045, 061, 085, 114
	Sanyo	032, 033, 053, 087, 091, 115, 116
	SBR	042
	Scott	017, 020, 086, 089, 093, 117
	Sears	013, 023, 028, 031, 033, 053, 054, 088, 091, 098, 099, 115
	Sentra	055
	Sharp	001, 002, 021, 097

	Shogun	087
	Sony	075, 076, 077, 078, 079, 121, 122
	STS	023
	Sylvania	009, 015, 016, 017, 041, 049, 094
	Symphonic	009, 094
T	Tandy	009
	Tashiko	009, 088
	Tatung	004, 026, 030
	Teac	004, 009, 026, 094
	Technics	024, 049
	Teknika	009, 010, 022, 049, 088, 094
	TMK	087, 092
	Toshiba	013, 017, 020, 041, 059, 089, 098, 099, 117
	Totevision	007, 087, 088
	Unirech	087
V	Vecrtr Research	005, 062, 085, 089, 090
	Victor	005, 045, 046, 085
	Video Concepts	005, 027, 085, 089, 090
	Videosonic	007, 087
W	Wards	013, 021, 023, 087, 088, 089, 091, 094, 097, 118, 119, 120
X	XR-1000	094
Y	Yamaha	004, 005, 006, 026, 062, 085
Z	Zenith	060, 078, 079

Television

A	Admiral	045, 121
	Adventura	122
	Aiko	054
	Akai	016, 027, 046
	Alleron	062
	A-Mark	007
	Amtron	061
	Anam	006, 007, 036
	Anam National	061, 147
	AOC	003, 007, 033, 038, 039, 047, 048, 049, 133
	Archer	007
	Audiovox	007, 061
B	Bauer	155
	Belcor	047
	Bell & Howell	045, 118
	Bradford	061
	Brockwood	003, 047
C	Candle	003, 030, 031, 032, 038, 047, 049, 050, 122
	Capehart	003

	Celebrity	046
	Circuit City	003
	Citizen	029, 030, 031, 032, 034, 038, 047, 049, 050, 054, 061, 095, 122, 123
	Concerto	031, 047, 049
	Colorlyme	003, 047, 049, 135
	Contec	013, 051, 052, 061
	Cony	051, 052, 061
	Craig	004, 061
	Crown	029
	Curtis Mathes	029, 034, 038, 044, 047, 049, 053, 095, 118
D	Daewoo	027, 029, 039, 048, 049, 054, 055, 106, 107, 137
	Daytron	003, 049
	Dimensia	044
	Dixi	007, 015, 027
E	Electroband	046
	Electrohome	029, 056, 057, 058, 147
	Elta	027
	Emerson	029, 051, 059, 060, 061, 062, 118, 123, 124, 139, 148
	Envision	038
	Etron	027
F	Fisher	014, 021, 063, 064, 065, 118
	Formenti	155
	Fortress	012
	Fujitsu	004, 062
	Funai	004, 062
	Futurtech	004
G	GE	020, 036, 037, 040, 044, 058, 066, 088, 119, 120, 125, 147
	Goldstar	000, 015, 029, 031, 039, 048, 051, 056, 057, 067, 068, 069, 116
	Grundy	062
H	Hitachi	029, 031, 051, 052, 070, 111, 112, 113, 124, *[134]
	Hitachi Pay TV	151
I	Infinity	017, 071
J	Janeil	122
	JBL	017, 071
	JC Penny	020, 034, 039, 040, 041, 044, 048, 050, 058, 066, 069, 076, 088, 090, 095, 125, 136, 159
	JCB	046
	JVC	019, 051, 052, 072, 073, 091, 117, 126
K	Kawasho	018, 046
	Kenwood	038, 056, 057
	Kloss	010, 032
	Kloss Novabeam	005, 122, 127, 131
	KTV	074, 123

L	Loewe	071
	Logik	144
	Luxman	031
	LXI	008, 014, 017, 024, 040, 044, 063, 071, 075, 076, 077, 118, 125
M	Magnavox	005, 010, 017, 030, 033, 038, 050, 056, 071, 078, 079, 085, 089, 108, 109, 110, 127, 131, 132, 145
	Marantz	015, 017, 071, 080
	Matsui	027
	Memorex	014, 027, 045, 083, 118, 144
	Metz	160, 161, 162, 163
	MGA	001, 039, 048, 056, 057, 058, 065, 081, 083
	Midland	125
	Minutz	066
	Mitsubishi	001, 016, 039, 048, 056, 057, 058, 065, 081, 082, 083, 105
	Montgomery Ward	011, 020, 144, 145, 146
	Motorola	121, 147
	MTC	031, 034, 039, 048, 095
N	NAD	008, 075, 076, 128
	National	002, 036, 061, 147
	National Quenties	002
	NEC	031, 038, 039, 048, 057, 084, 086, 135, 147
	Nikko	054
	NTC	054
O	Optimus	128
	Optonica	011, 012, 093, 121
	Orion	004, 139
P	Panasonic	002, 009, 017, 036, 037, 071, 141, 143, 147
	Philco	005, 010, 030, 050, 051, 056, 079, 085, 127, 131, 132, 145, 147
	Philips	005, 015, 017, 050, 051, 056, 078, 087, 088, 089, 131, 132, 147
	Pioneer	124, 128, 142
	Portland	054
	Price Club	095
	Proscan	040, 044, 125
	Proton	035, 051, 092, 129
	Pulsar	042
Q	Quasar	036, 037, 074, 141
R	Radio Shack	011, 044, 063, 093, 118
	RCA	040, 044, 125, 130, 137, 151, 152
	Realistic	014, 063, 093, 118
S	Saisho	027
	Samsung	003, 015, 034, 053, 055, 057, 094, 095, 136, 153
	Sansui	139
	Sanyo	013, 014, 021, 022, 063, 064, 081, 096
	SBR	015

	Schneider	015
	Scott	062
	Sears	008, 014, 021, 022, 023, 024, 025, 040, 052, 057, 062, 063, 064, 065, 073, 075, 076, 097, 098, 125, 159
	Sharp	011, 012, 013, 026, 093, 099, 100, 104, 121
	Siemens	013
	Signature	045, 144
	Simpson	050
	Sony	043, 046, 138, 146, 150
	Soundesign	030, 050, 062
	Spectricon	007, 033
	Squareview	004
	Supre-Macy	032, 122
	Supreme	046
	Sylvania	005, 010, 017, 030, 078, 079, 085, 089, 101, 127, 131, 132, 145, 155
	Symphonic	004, 148
T	Tandy	012, 121
	Tatung	036, 124
	Technics	037
	Teknika	001, 030, 032, 034, 052, 054, 078, 083, 095, 144, 156, 157
	Tera	035, 129
	THOMSON	165, 166
	Toshiba	008, 014, 034, 063, 075, 076, 095, 097, 136, 158, 159
U	Universal	020, 066, 088
V	Victor	019, 073, 126
	Video Concepts	016
	Viking	032, 122
W	Wards	005, 045, 066, 078, 085, 088, 089, 093, 102, 103, 131, 132, 148
Z	Zenith	042, 114, 115, 140, 144, 149
	Zonda	007

CABLE

A	ABC	006, *[007], 008, 009
	Archer	010, 011
C	Century	011
	Citizen	011
	Colour Voice	012, 013
	Comtronic	014
E	Eastern	015
G	Garrard	011
	Gemini	030, 033, 034
	General Instrument	030, 031, 032
H	Hytex	006
J	Jasco	011
	Jerrold	009, 016, 017, 026, 032
M	Magnavox	018

	Movie Time	019
N	NSC	019
O	Oak	000, 006, 020
P	Panasonic	001, 005
	Philips	011, 012, 013, 018, 021
	Pioneer	002, 003, 022
R	RCA	029
	Regency	015
S	Samsung	014, 023
	Scientific Atlanta	004, 024, 025
	Signal	014
	SL Marx	014
	Starcom	009
	Stargate	014
T	Televue	014
	Tocom	007, 016
	TV86	019
U	Unika	011
	United Artists	006
	Universal	010, 011
V	Viewstar	018, 019
Z	Zenith	027, 028

Satellite Receiver

A	Alphastar	054
C	Chaparral	035, 036
D	Dishnet	053
	Drake	037, 038
E	Echostar Dish	062, 066
G	GE	048, 055, 056
	General Instruments	039, 040, 041
	Grundig	070, 071, 072, 073
H	Hitachi	058, 059
	Hughes Network	063, 064, 065, 069
J	JVC	057
K	Kathrein	074, 075, 076, 083
M	Magnavox	060
N	Nokia	070, 080, 084, 085, 086
P	Philips	060
	Primestar	051
	Proscan	048, 055, 056
R	RCA	048, 055, 056, 068
	Realistic	042
S	Sierra I	036
	Sierra II	036
	Sierra III	036
	Sony	049, 067
	STS1	043
	STS2	044
	STS3	045
	SRS4	046

T	Technisat	077, 078, 079, 081, 082
	Toshiba	047, 050
U	Uniden	061

CD Player

A	Aiwa	001, 035, 043
B	Burmster	002
C	Carver	003, 035
D	Denon	*[111], 044
E	Emerson	004, 005, 006, 007
F	Fisher	003, 008, 009, 010
J	JVC	018, 019
K	Kenwood	011, 012, 013, 014, 017
M	Magnavox	006, 015, 035
	Marantz	016, 028, 035
	MCS	016, 024
O	Onkyo	025, 027
	Optimus	017, 020, 021, 022, 023
P	Philips	014, 032, 033, 035
	Pioneer	006, 022, 030
S	Sears	006
	Sony	023, 031
T	Teac	002, 009, 028
	Technics	016, 029, 036
W	Wards	035, 037
Y	Yamaha	038, 039, 040, 041
Z	Zenith	042

CD Recorder

D	Denon	*[111], 112
P	Philips	112

MD

D	Denon	113
K	Kenwood	003, 004
O	Onkyo	007
S	Sharp	005
	Sony	006

TAPE

A	Aiwa	001, 002
C	Carver	002
D	Denon	*[111]
H	Harman/Kardon	002, 003
J	JVC	004, 005
K	Kenwood	006
M	Magnavox	002
	Marantz	002
O	Onkyo	016, 018

	Optimus	007, 008
P	Panasonic	012
	Philips	012
	Pioneer	007, 008, 009
S	Sony	013, 014, 015
T	Technics	012
V	Victor	004
W	Wards	007
Y	Yamaha	010, 011

[]*: Preset codes set upon shipment from the factory.

: Sie Voreinstellungscodes wurden vor der Auslieferung werkseitig eingestellt.

: Les codes pré-réglés différent en fonction des livraisons de l'usine.

: I codici di presettaggio sono impostati in fabbrica prima della consegna.

: Los códigos vienen preprogramados de fábrica.

: Vooringestelde codes bij het verlaten van de fabriek.

: Förinställda koder har ställts in vid transporten från fabriken.

DVD preset codes DVD-Voreinstellungscodes Codes pré-réglés DVD Codici di preselezione DVD Códigos de preajuste de DVD DVD-voorkeuzecodes Förinställda DVD-koder

DENON	111	014
Model No.	DVD-550	DVD-800
Modellnr	DVD-700	DVD-1600
Modèle numéro	DVD-900	DVD-2000
Modello No	DVD-1000	DVD-2500
Nº de modelo	DVD-1400	DVD-3000
Modelnr	DVD-1500	DVD-3300
Modellnr	DVD-1710	
	DVD-1910	
	DVD-2200	
	DVD-2800	
	DVD-2800II	
	DVD-2900	
	DVD-2910	
	DVD-3800	
	DVD-3910	
	DVD-A11	
	DVD-A1	
	DVD-A1XV	



DENON

www.denon.com

Denon Brand Company, D&M Holdings Inc.
Printed in China 00D 511 4622 104